

Hardware Specifications

MONITOUCH V8

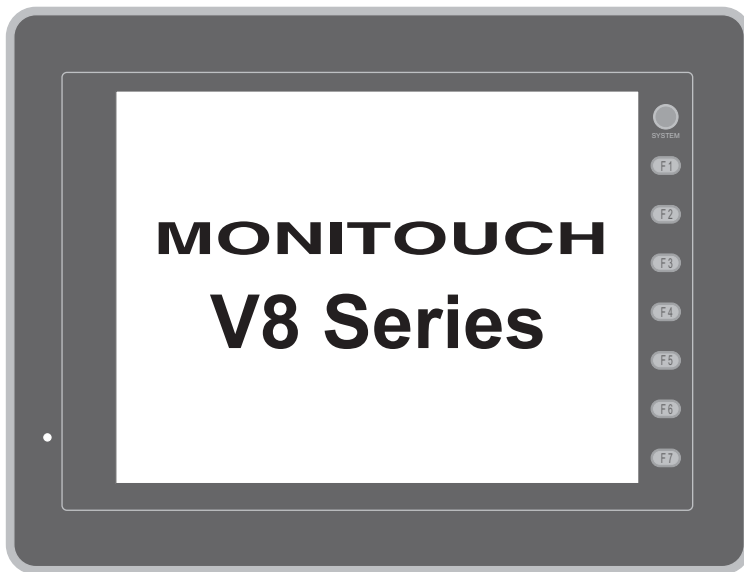

Preface

Thank you for selecting the V8 series.

For correct set-up of the V8 series, you are requested to read through this manual to understand more about the product.

The manuals shown below are related manuals for the V8 series. Refer to them as necessary.

Manual Name	Contents	Reference No.
V8 Series Reference Manual	The functions and instructions of the V8 series are explained.	1055NE
V8 Series Reference Additional Functions	Additional specifications for the Reference Manual are explained.	1060NE
V Series Macro Reference	An overview of macros as well as macro editor operations and macro command descriptions are explained in detail.	1056NE
V8 Series Introductory Manual	The basic operating procedure of V-SFT version 5 is explained in detail.	1057NE
V8 Series Connection Manual	The connection and communication parameters for the V8 series and controllers are explained in detail.	2201NE
V Series DLL Function Specifications	An overview and contents of DLL files used for Ethernet (HKEtn20.DLL) and CF card (VCFACs.DLL) are explained in detail.	1059NE

For further details about controllers (PLCs, temperature controllers, etc.), refer to the manual issued by each controller manufacturer.

Notes:

1. This manual may not, in whole or in part, be printed or reproduced without the prior written consent of Hakko Electronics Co., Ltd.
2. The information in this manual is subject to change without prior notice.
3. Windows and Excel are registered trademarks of Microsoft Corporation in the United States and other countries.
4. All other company names or product names are trademarks or registered trademarks of their respective holders.
5. If the specifications of the software do not correspond with the contents of this manual, the software specifications have priority.

Notes on Safe Usage of MONITOUCH

In this manual, you will find various notes categorized under the following levels with the signal words "DANGER," and "CAUTION."



DANGER

Indicates an imminently hazardous situation which, if not avoided, will result in death or serious injury.



CAUTION

Indicates a potentially hazardous situation which, if not avoided, may result in minor or moderate injury and could cause property damage.

Note that there is a possibility that the item listed with  CAUTION may have serious ramifications.



DANGER

- Never use the output signal of MONITOUCH for operations that may threaten human life or damage the system, such as signals used in case of emergency. Please design the system so that it can cope with the malfunctions of a touch switch. A malfunction of a touch switch will result in machine accident or damage.
- Turn off the power supply when you set up the unit, connect new cables or perform maintenance or inspections. Otherwise, electrical shock or damage may occur.
- Never touch any terminals while the power is on. Otherwise, electric shock may occur.
- You must put a cover on the terminals on the unit when you turn the power on and operate the unit. Otherwise, electric shock may occur.
- The liquid crystal in the LCD panel is a hazardous substance. If the LCD panel is damaged, do not ingest the leaked liquid crystal. If the liquid crystal spills on skin or clothing, use soap and wash off thoroughly.
- Never disassemble, recharge, deform by pressure, short-circuit, reverse the polarity of the lithium battery, nor dispose of the lithium battery in fire. Failure to follow these conditions will lead to explosion or ignition.
- Never use a lithium battery that is deformed, leaks, or shows any other signs of abnormality. Failure to follow these conditions will lead to explosion or ignition.
- The power lamp flashes when the backlight is at the end of life or is faulty. However, the switches on the screen are operable at this time. Do not touch the screen when the screen becomes dark and the power lamp flashes. Otherwise, a malfunction may occur and result in machine accident or damage.

CAUTION

- Check the appearance of the unit when it is unpacked. Do not use the unit if any damage or deformation is found. Failure to do so may lead to fire, damage or malfunction.
- For use in a facility or for a system related to nuclear energy, aerospace, medical, traffic equipment, or mobile installations, please consult your local distributor.
- Operate (or store) MONITOUCH under the conditions indicated in this manual and related manuals. Failure to do so could cause fire, malfunction, physical damage or deterioration.
- Understand the following environmental limits for use and storage of MONITOUCH. Otherwise, fire or damage to the unit may result.
 - Avoid locations where there is a possibility that water, corrosive gas, flammable gas, solvents, grinding fluids or cutting oil can come into contact with the unit.
 - Avoid high temperature, high humidity, and outside weather conditions, such as wind, rain or direct sunlight.
 - Avoid locations where excessive dust, salt, and metallic particles are present.
 - Avoid installing the unit in a location where vibration or physical shock may be transmitted.
- Equipment must be correctly mounted so that the main terminal of MONITOUCH will not be touched inadvertently. Otherwise, an accident or electric shock may occur.
- Tighten the fixtures of MONITOUCH with a torque in the specified range. Excessive tightening may distort the panel surface. Loose tightening may cause MONITOUCH to come off, malfunction or be short-circuited.
- Check periodically that terminal screws on the power supply terminal block and fixtures are firmly tightened. Loosened screws may result in fire or malfunction.
- Tighten terminal screws on the power supply terminal block equally to a torque of 0.8 N•m for MONITOUCH. Improper tightening of screws may result in fire, malfunction, or trouble.
- MONITOUCH has a glass screen. Do not drop or give physical shock to the unit. Otherwise, the screen may be damaged.
- Connect the cables correctly to the terminals of MONITOUCH in accordance with the specified voltage and wattage. Over-voltage, over-wattage, or incorrect cable connection could cause fire, malfunction or damage to the unit.
- Be sure to establish a ground of MONITOUCH. The FG terminal must be used exclusively for the unit with the level of grounding resistance less than 100 Ω. Otherwise, electric shock or a fire may occur.
- Prevent any conductive particles from entering into MONITOUCH. Failure to do so may lead to fire, damage, or malfunction.
- After wiring is finished, remove the paper used as a dust cover before starting to operate MONITOUCH. Operation with the cover attached may result in accident, fire, malfunction, or trouble.
- Do not attempt to repair MONITOUCH at your site. Ask Hakko Electronics or the designated contractor for repair.
- Do not repair, disassemble or modify MONITOUCH. Hakko Electronics Co., Ltd. is not responsible for any damages resulting from repair, disassembly or modification of MONITOUCH that was performed by an unauthorized person.
- Do not use a sharp-pointed tool when pressing a touch switch. Doing so may damage the screen. Doing so may damage the screen.
- Only experts are authorized to set up the unit, connect the cables or perform maintenance and inspection.
- Lithium batteries contain combustible material such as lithium or organic solvent. Mishandling may cause heat, explosion or ignition resulting in fire or injury. Read related manuals carefully and handle the lithium battery correctly as instructed.
- When using a MONITOUCH that has analog switch resolution with resistance film, do not press two or more points on the screen at the same time. If two or more positions are pressed at the same time, the switch located between the pressed positions activates.
- Take safety precautions during such operations as setting change during running, forced output, start, and stop. Any misoperation may cause unexpected machine motions, resulting in machine accident or damage.
- In facilities where a failure of MONITOUCH could lead to accident threatening human life or other serious damage, be sure that the facilities are equipped with adequate safeguards.
- At the time of disposal, MONITOUCH must be treated as industrial waste.
- Before touching MONITOUCH, discharge static electricity from your body by touching grounded metal. Excessive static electricity may cause malfunction or trouble.
- Insert the CF card into the V8 unit in the correct orientation. Failure to do so may damage the CF card or the socket at the unit.
- The LED lamp on the CF card interface cover illuminates in red when the power is supplied to the CF card. Never remove the CF card or turn off the power of MONITOUCH while the LED lamp is lit. Doing so may destroy the data on the CF card. Check that the LED lamp has gone off before removing the CF card or turning off the power of MONITOUCH.

[General Notes]

- Never bundle control cables nor input/output cables with high-voltage and large-current carrying cables such as power supply cables. Keep these cables at least 200 mm away from the high-voltage and large-current carrying cables. Otherwise, malfunction may occur due to noise.
- When using MONITOUCH in an environment where a source of high-frequency noise is present, it is recommended that the FG shielded cable (communication cable) be grounded at its ends. However, the cable may be grounded only at one end if this is necessary due to unstable communication conditions or for any other reason.
- Plug connectors or sockets of MONITOUCH in the correct orientation. Failure to do so may lead to damage or malfunction.
- If a LAN cable is inserted into the MJ1 or MJ2 connector on MONITOUCH, the counterpart device may be damaged. Check the indication on the unit and insert a cable into the correct position.
- Do not use thinners for cleaning because they may discolor MONITOUCH surface. Use alcohol or benzine commercially available.
- If a data receive error occurs when MONITOUCH and the counterpart (PLC, temperature controller, etc.) are started at the same time, read the manual for the counterpart unit and remove the error correctly.
- Avoid discharging static electricity on the mounting panel of MONITOUCH. Static charges can damage the unit and cause malfunctions. Otherwise, malfunction may occur due to noise.
- Avoid prolonged display of any fixed pattern. Due to the characteristics of the liquid crystal display, an afterimage may occur. If a prolonged display of a fixed pattern is expected, use the auto OFF function of the backlight.

[Notes on LCD]

Note that the following conditions may occur under normal circumstances.

- The response time, brightness and colors of MONITOUCH may be affected by the ambient temperature.
- Tiny spots (dark or luminescent) may appear on the display due to the liquid crystal characteristics.
- There are variations in brightness and colors on each unit.
- Cold cathode tubes are incorporated into the LCD display for backlights. Optical properties (brightness, irregular colors, etc.) may change in a low-temperature environment or over time of operation.

Contents

Preface

Notes on Safe Usage of MONITOUCH

Chapter 1	Product Outline	
	1. Features	1-1
	2. Models and Peripheral Equipment	1-2
	MONITOUCH Models	1-2
	Peripheral Equipment	1-4
	3. System Composition	1-7
	System Composition of V8i/V8iC Series	1-7
	System Composition of V8/V8C Series.....	1-8
Chapter 2	Specifications	
	1. Specifications	2-1
	General Specifications	2-1
	Installation Specifications.....	2-4
	Display Specifications	2-4
	Touch Switch Specifications	2-4
	Function Switch Specifications.....	2-4
	Interface Specifications	2-5
	Clock and Backup Memory Specifications	2-5
	Drawing Environment.....	2-6
	Display Function Specifications	2-6
	Function Performance Specifications.....	2-7
	2. Dimensions and Panel Cut-out.....	2-8
	External Dimensions and Panel Cut-out Dimensions for V812S / V812iS.....	2-8
	External Dimensions and Panel Cut-out Dimensions for V810S / V810iS / V810T / V810iT.....	2-9
	External Dimensions and Panel Cut-out Dimensions for V810C / V810iC	2-10
	External Dimensions and Panel Cut-out Dimensions for V808S / V808iS.....	2-11
	External Dimensions and Panel Cut-out Dimensions for V808C / V808iC	2-12
	3. Names and Functions of Components	2-13
	4. Serial Connector (CN1)	2-16
	Connector for a Controller.....	2-16
	5. Modular Jack (MJ1 / MJ2)	2-17
	Modular Jack 1 (MJ1) / 2 (MJ2)	2-17
	6. USB Connector	2-20
	USB-A (Master Port)	2-20
	USB-B (Slave Port)	2-24
	Securing USB Cable	2-29

7. LAN Connector (LAN).....	2-32
LAN Connector.....	2-32
Wiring.....	2-33
8. CF Card	2-34
CF Card Connector.....	2-34
Notes on Handling the CF Card.....	2-35

Chapter 3 Installation

1. Mounting Procedure.....	3-1
Mounting Procedure.....	3-1
Mounting Angle	3-2
2. Power Supply Cable Connection	3-3
Power Supply Cable Connection	3-3
Notes on Usage of 100 - 240 VAC Specifications.....	3-4
Grounding	3-4

Chapter 4 Instructions

1. Coin-type Lithium Battery (V7-BT)	4-1
Battery Usage	4-1
Battery Mounting Procedure	4-1
Battery Voltage Drop Detection.....	4-2
Battery Replacement.....	4-3
2. DIP Switches.....	4-5
DIP Switch (DIPSW) Setting	4-5
3. Function Switches.....	4-7
Types	4-7
Function of Switches.....	4-7

Chapter 5 MONITOUCH Operations

1. Before Operation.....	5-1
Procedure before Operation.....	5-1
Transferring Screen Data to MONITOUCH for the First Time	5-2
2. Main Menu Screen.....	5-3
Displaying the Main Menu Screen	5-3
Main Menu Screen	5-3
[Main Menu] Switch.....	5-4
Main Menu Screen Composition	5-4
1. RUN.....	5-5
2. Language Selection.....	5-5
3. Communication Parameter.....	5-6
4. Ethernet.....	5-7
4-1. IP Address Setting of the V8 Series	5-8
5. SRAM/Clock	5-11
5-1. Date and Time Adjustment.....	5-12
5-2. Formatting SRAM.....	5-12

5-3.	Japanese FEP Function Learning/User Phrase Area	5-13
6.	Extension Program Information	5-14
7.	Card Transfer	5-15
7-1.	Folder Configuration in the CF Card	5-17
7-2.	Transferring Screen Data	5-18
7-3.	Saving Backup Copies of SRAM	5-24
7-4.	Transferring Ethernet Table (Under Development)	5-26
7-5.	Deleting Data on the CF Card	5-27
7-6.	Transferring Data to the Card Recorder	5-28
7-7.	Message Dialog Displayed during Data Transfer (between V8 and Card)	5-30
8.	RGB Adjustment	5-31
8-1.	Adjusting the Display Position of the RGB Screen	5-32
9.	I/O Test	5-34
9-1.	Self-loop Test	5-35
9-2.	USB Test	5-40
9-3.	Printer Test	5-40
9-4.	[SYSTEM] Switch & Function Switch Test	5-41
9-5.	Touch Switch Test	5-42
9-6.	Keyboard Selection	5-44
10.	Extended Function Setting	5-45
10-1.	Setting Baud Rate between V8 Series and Modem	5-46
10-2.	Setting V-Link Local Port Number	5-47
10-3.	Local Port Number Setting for Modbus Slave Communication	5-47

Chapter 6 Error Handling

1.	Error Messages	6-1
1.	Communication Error	6-1
1-1.	Error Messages for Network Communication	6-2
2.	Data Loading	6-6
3.	Warning	6-6
4.	SYSTEM ERROR	6-7
5.	Touch Switch Is Active	6-7
2.	Troubleshooting	6-8
In the Event of an Error	6-8	
Probable Symptoms	6-8	

Chapter 7 Inspection and Maintenance

1.	Inspection and Maintenance	7-1
Daily Inspection	7-1	
Periodical Inspection	7-1	

2. Warranty Policy.....	7-2
Inquiries about Failure.....	7-2
Warranty Period	7-2
Free-of-charge Repair.....	7-2
Chargeable Repair	7-2
Inquiry Form	7-3

1 Product Outline

1. Features
2. Models and Peripheral Equipment
3. System Composition

1. Features

The V8 series inherits and heightens the features of the V7 series as described below.

1. 8-way communication

A maximum of eight controllers, such as PLCs or peripheral equipment, of different models and manufacturers can be connected to one V8 series via mixed network of Ethernet (max. 8 protocols) and serial communications (max. 3 protocols).

The V8 series can communicate with eight types of devices at one time and can exchange data among connected devices.

Connection example: serial 3 ports + Ethernet

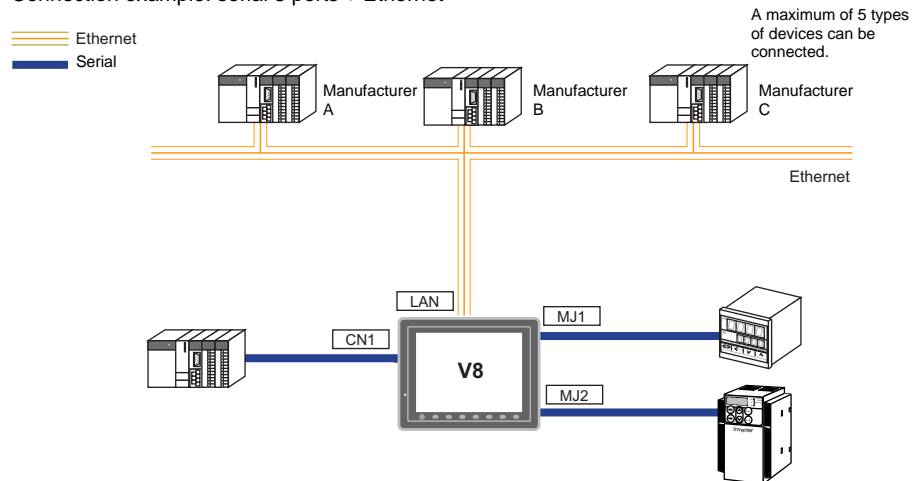

2. 65536-color display

A high-definition display of 65,536 colors (without blinks, 32,768 colors with blinks) is possible. Photographs (JPEG) or illustrations (bitmap) are displayed close to the real image. An operator can view operating conditions easily because of the increased viewability.

3. 16770k-color display & 30-frame display per second for video (V812iS/V810iS/V810iT/V808iS only)

Video image is displayed in 16770k-color and with 30 frames per second. Even if takt time is short, the video image can be displayed in real time.

* For V808iS: 260k-color

4. Stroke font

Unlike standard bitmap fonts, the font size can be adjusted as desired regardless of the display resolution. Quality expression is possible.

5. Process for screen data creation is reduced with use of "component parts".

A "component part" is a part which consists of multiple components having different functions or different macro programs.

Screen data with advanced functions can be created easily and rapidly.

6. CF-card 2 drives provided

CF cards can be used at the same time in both built-in CF interface and USB-CFREC.

Data can be transmitted between two CF cards. You can use CF cards for various purposes as required.

7. PictBridge-compatible printer available

A PictBridge-compatible printer can be connected.

Simple printing using a USB cable is possible.

2. Models and Peripheral Equipment

MONITOUCH Models

The model name consists of the following information.

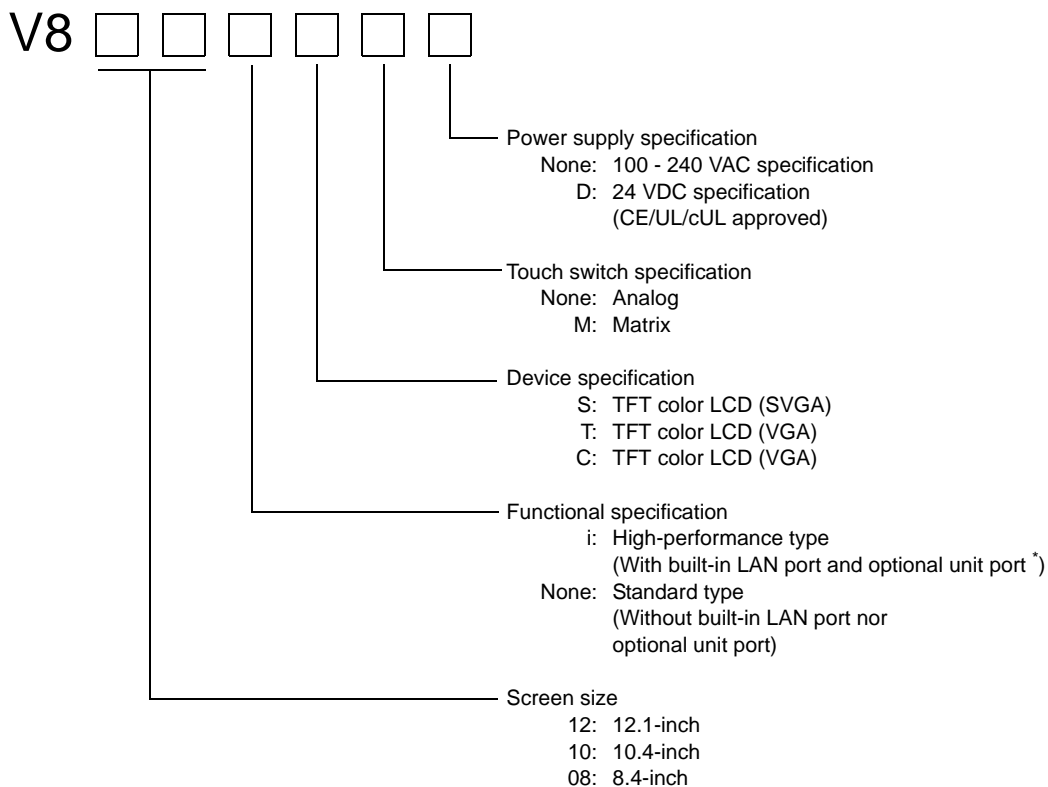

* V810iC/ V808iC: without optional unit port

The following models are available.

Analog resistance film type

Series	Model	Specifications	Remarks
V812 series 12-inch	V812S	TFT color, 800 × 600 dots, standard, AC power supply	
	V812SD	TFT color, 800 × 600 dots, standard, DC power supply	CE/UL/cUL approved
	V812iS	TFT color, 800 × 600 dots, high-performance, AC power supply	
	V812iSD	TFT color, 800 × 600 dots, high-performance, DC power supply	CE/UL/cUL approved
V810 series 10-inch	V810S	TFT color, 800 × 600 dots, standard, AC power supply	
	V810SD	TFT color, 800 × 600 dots, standard, DC power supply	CE/UL/cUL approved
	V810iS	TFT color, 800 × 600 dots, high-performance, AC power supply	
	V810iSD	TFT color, 800 × 600 dots, high-performance, DC power supply	CE/UL/cUL approved
	V810T	TFT color, 640 × 480 dots, standard, AC power supply	
	V810TD	TFT color, 640 × 480 dots, standard, DC power supply	CE/UL/cUL approved
	V810iT	TFT color, 640 × 480 dots, high-performance, AC power supply	
	V810iTD	TFT color, 640 × 480 dots, high-performance, DC power supply	CE/UL/cUL approved
	V810C	TFT color, 640 × 480 dots, standard, AC power supply	

Series	Model	Specifications	Remarks
V810 series 10-inch	V810CD	TFT color, 640 × 480 dots, standard, DC power supply	CE/UL/cUL approved
	V810iC	TFT color, 640 × 480 dots, high-performance, AC power supply	
	V810iCD	TFT color, 640 × 480 dots, high-performance, DC power supply	CE/UL/cUL approved
V808 series 8-inch	V808SD	TFT color, 800 × 600 dots, standard, DC power supply	CE/UL/cUL approved
	V808iSD	TFT color, 800 × 600 dots, high-performance, DC power supply	
	V808CD	TFT color, 640 × 480 dots, standard, DC power supply	
	V808iCD	TFT color, 640 × 480 dots, high-performance, DC power supply	

Matrix resistance film type

Series	Model	Specifications	Remarks
V812 series 12-inch	V812SM	TFT color, 800 × 600 dots, standard, AC power supply	
	V812SMD	TFT color, 800 × 600 dots, standard, DC power supply	CE/UL/cUL approved
	V812iSM	TFT color, 800 × 600 dots, high-performance, AC power supply	
	V812iSMD	TFT color, 800 × 600 dots, high-performance, DC power supply	CE/UL/cUL approved
V810 series 10-inch	V810TM	TFT color, 640 × 480 dots, standard, AC power supply	
	V810TMD	TFT color, 640 × 480 dots, standard, DC power supply	CE/UL/cUL approved
	V810iTM	TFT color, 640 × 480 dots, high-performance, AC power supply	
	V810iTMD	TFT color, 640 × 480 dots, high-performance, DC power supply	CE/UL/cUL approved
	V810CM	TFT color, 640 × 480 dots, standard, AC power supply	
	V810CMD	TFT color, 640 × 480 dots, standard, DC power supply	CE/UL/cUL approved
	V810iCM	TFT color, 640 × 480 dots, high-performance, AC power supply	
	V810iCMD	TFT color, 640 × 480 dots, high-performance, DC power supply	CE/UL/cUL approved

Peripheral Equipment

The following devices are available as options for the V8 series.

Drawing Tool

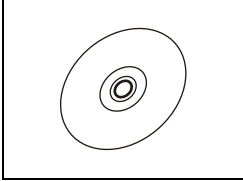

V-SFT-5 (configuration software: English version)
Application software for editing screen data for MONITOUCH.
(Windows98SE/NT4.0/Me/2000/XP/XP 64 Edition/Vista 32-bit compatible)

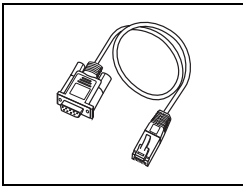

V-CP (screen data transfer cable) 3 m
Used for connection between the V8 series and a computer, or a computer and the card recorder (CREC).

Optional Unit

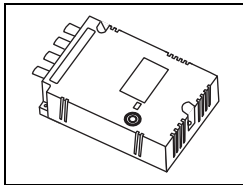

GU-xx
Optional unit for the V812iS/ V810iS/ V810iT/ V808iS
GU-00 → Video input (4 channels) + sound output (1 channel)
GU-01 → RGB input (1 channel) + sound output (1 channel)
GU-02 → RGB output (1 channel) + sound output (1 channel)
GU-03 → Sound output (1 channel)
GU-10 → Video input (2 channels) + RGB input (1 channel)
GU-11 → RGB input (2 channels)

Communication Interface Unit

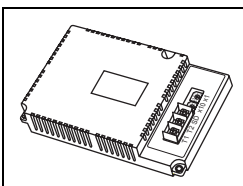

CU-xx
Communication unit used for each network
CU-00 → OPCN-1
CU-01 → T-LINK
CU-02 → CC-LINK
CU-03-3 → Ethernet
CU-04 → PROFIBUS-DP
CU-06 → SX BUS
CU-07 → DeviceNet (I/F driver under development)
CU-08 → FL-NET

Cable



V6-BCD (barcode reader connection cable) 3 m
Used for connection between the V8 series and a barcode reader.

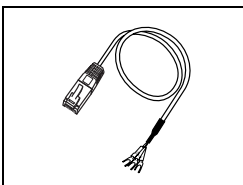

V6-MLT (multi-link 2 master cable) 3 m
Used for multi-link 2 connection between the V8 master station and the V8 slave station.

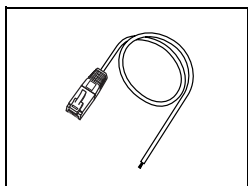
**V6-TMP (connection cable for controllers)**

Used for connection between the V8 series and a controller.

V6-TMP: 3 m
 V6-TMP-5M: 5 m
 V6-TMP-10M: 10 m

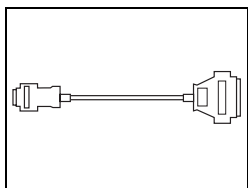
**D9-D25 (D-sub9 to D-sub25 conversion cable) 0.1 m**

Conversion cable for use of the communication cable used at CN1 (D-sub 25 pin) of the V6/V7 series at CN1 (D-sub 9 pin) of the V8 series

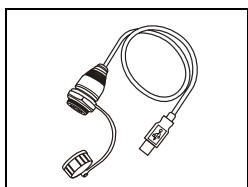
**UA-FR (for USB-A port) 1 m**

Cable for USB-A (master), with which connection from the front of the control cabinet is possible.

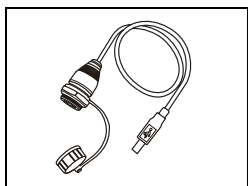
**UB-FR (for USB-B port) 1 m**

Cable for USB-B (slave), with which connection from the front of the control cabinet is possible.

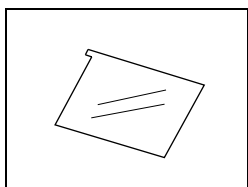
Protective Sheet**V8xx-GS**

Used for protecting the operation panel surface (5 pcs./set).

V812-GS → V812 series
 V810-GS → V810 series
 V808-GS → V808 series

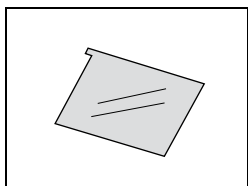
**V8xx-GSN10**

Used for protecting the operation panel surface (5 pcs./set, anti-glare treated).

The sheet is colored in light gray and has graininess on its surface to avoid light reflection.

V812-GSN10 → V812 series
 V810-GSN10 → V810 series
 V808-GSN10 → V808 series

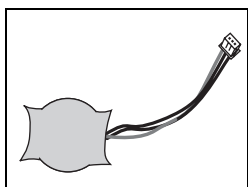
Other Options**V7-BT (replacement battery)**

Replacement lithium battery for the V8 series, V7 series and V606e.

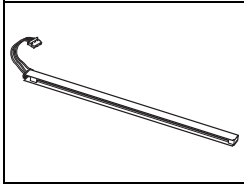

V8xxx-FL (replacement backlight for TFT)

Replacement backlight for the V8 series.
 V812-FL → V812 series
 V810-FL → V810S/V810T/V810C series
 V808S-FL → V808S series
 V808C-FL → V808C series

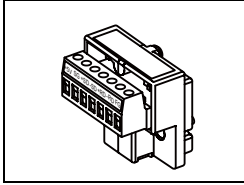

TC-D9 (terminal converter)

Used for connection between the V8 series and a controller at the RS-422/485 terminal block via CN1 (D-sub 9-pin).

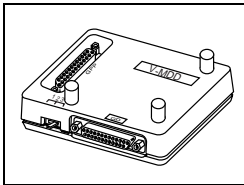

V-MDD (ACPU/QnACPU/FXCPU dual port interface)

Add-on connector with two ports, specifically designed for the connector on the MITSUBISHI's ACPU/QnACPU/FXCPU programmer. Operability can be improved when directly connecting the V8 series to the ACPU/QnACPU/FXCPU programmer.

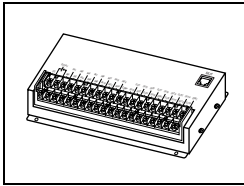

V-I/O (serial extension I/O)

Used as an external I/O unit. It has 16 inputs and 16 outputs.

Card Recorder

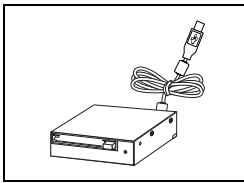

USB-CFREC (USB CF card recorder)

Unit that connects to the USB-A port of the V8 series and makes a CF card available.

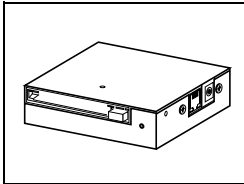

CREC (card recorder)

Used for creating a backup copy of screen data or works as an external memory storage system for memory manager and data logging functions by connecting to the MJ port.

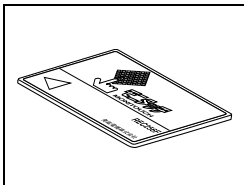

REC-MCARD (memory card compliant with JEIDA ver. 4.0)

Used with the card recorder (CREC) when making a backup copy of screen data or saving data on an external medium for memory manager and data logging functions.

SRAM 256 K, 512 K, 1 M, 2 M, 4 Mbytes
 FLASH ROM 4 Mbytes

3. System Composition

System Composition of V8i/V8iC Series

The following illustration shows possible system configurations using the V8i/V8iC series.

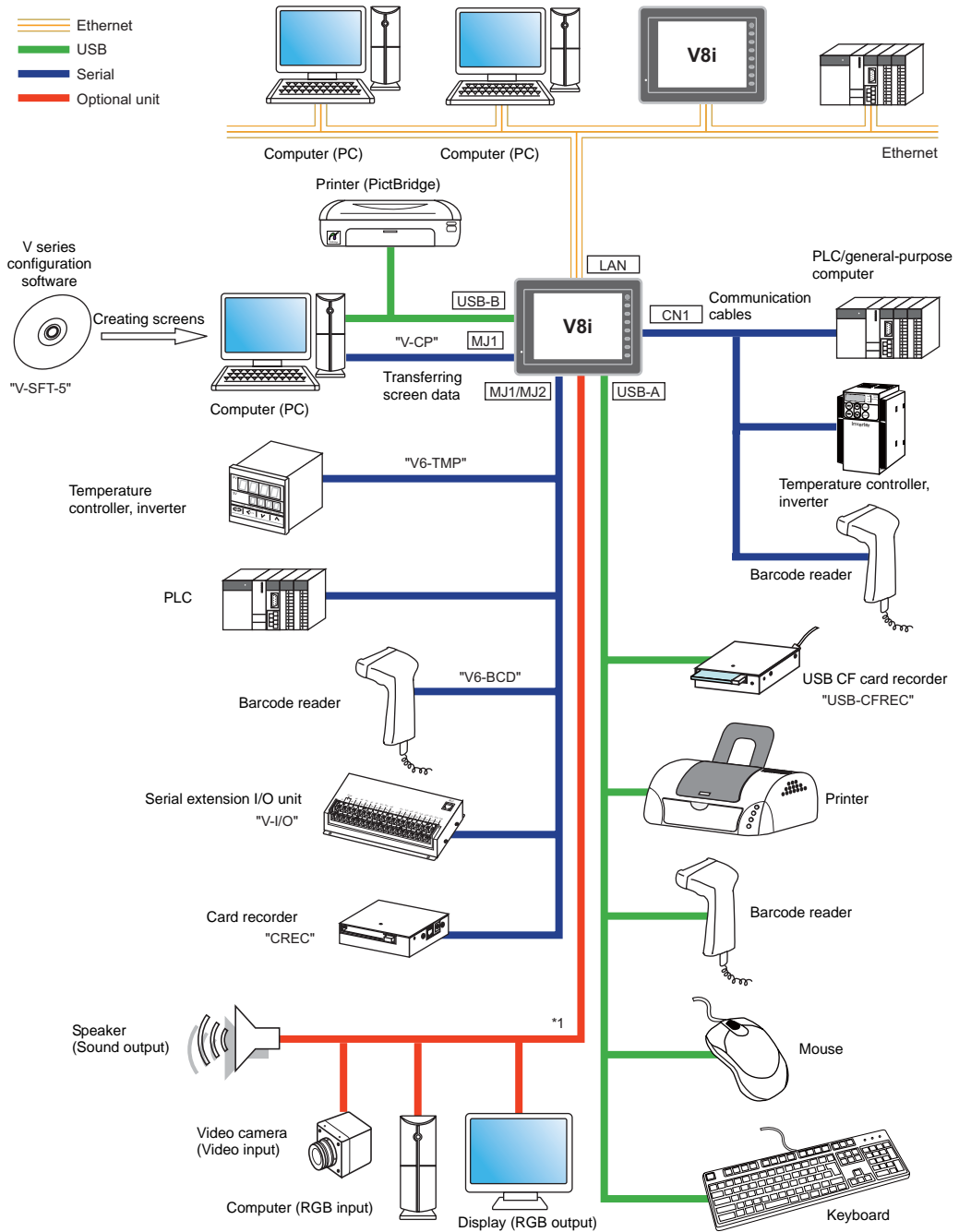

*1 For the V8i series only. The option unit (GU-xx) is required.

System Composition of V8/V8C Series

The following illustration shows possible system configurations using the V8/V8C series.

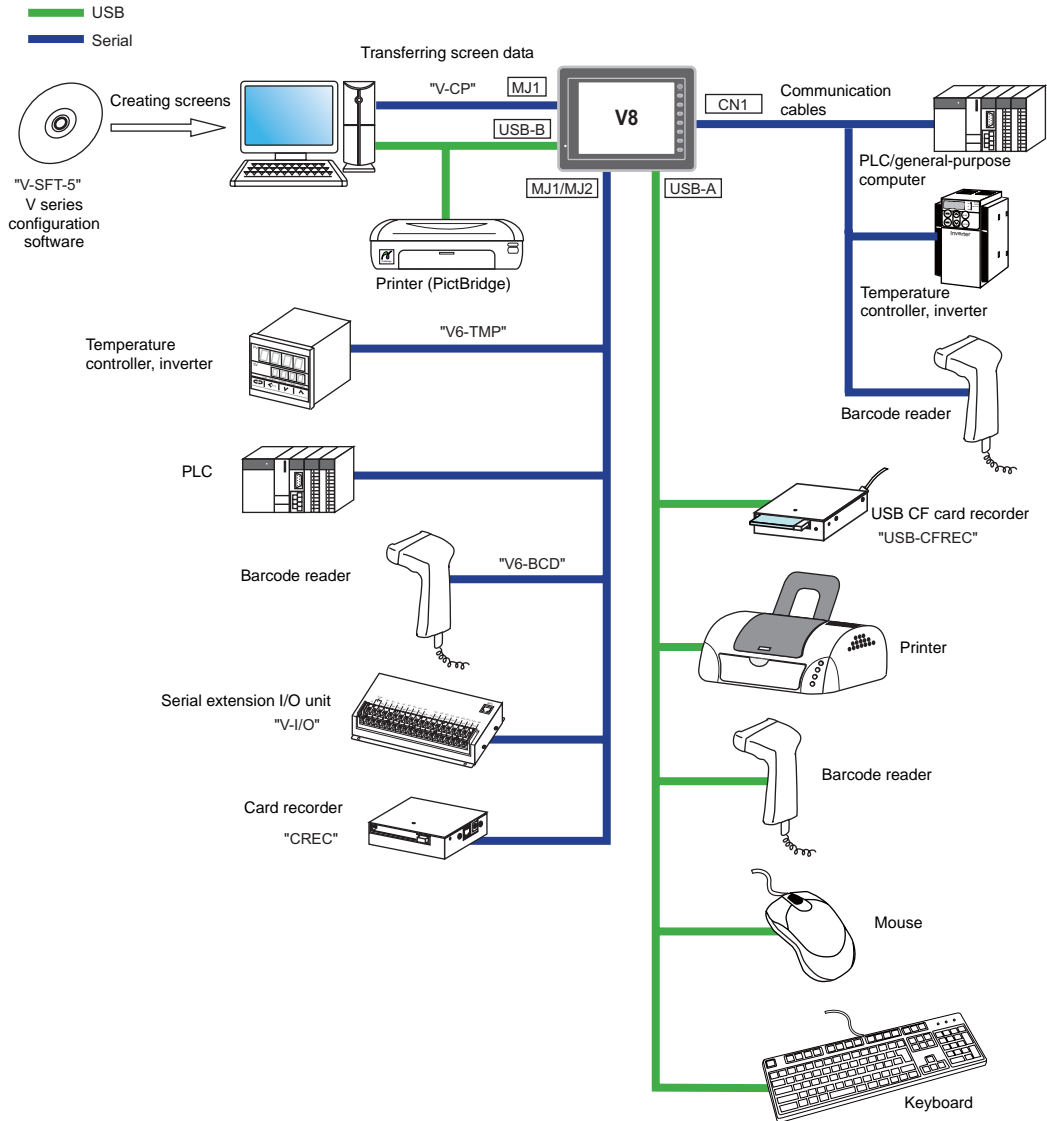

2 Specifications

1. Specifications
2. Dimensions and Panel Cut-out
3. Names and Functions of Components
4. Serial Connector (CN1)
5. Modular Jack (MJ1 / MJ2)
6. USB Connector
7. LAN Connector (LAN)
8. CF Card

1. Specifications

General Specifications

Item		V812		V810			V808			
		V812xS	V812xSD	V810xS V810xT	V810xC	V810xSD V810xTD	V810xCD	V808xSD	V808xCD	
Standards	CE Marking	-	EN61000-6-2 EN61000-6-4	-			EN61000-6-2 EN61000-6-4	EN61000-6-2 EN61000-6-4		
	UL/cUL	-	UL508 UL1604 *1	-			UL508 UL1604 *1	UL508 UL1604 *1		
Power Supply	Permissible Range of Voltage	100 - 240 VAC ± 10 % (47 to 63 Hz)	24 VDC ± 10 % *2	100 - 240 VAC ± 10 % (47 to 63 Hz)		24 VDC ± 10 % *2		24 VDC ± 10 % *2		
	Permissible Momentary Power Failure	Within 20 ms	For 24 VDC: Within 1 ms	Within 20 ms		For 24 VDC: Within 1 ms		For 24 VDC: Within 1 ms		
	Power Consumption (Maximum Rating)	70 VA or less	30 W or less	70 VA or less	60 VA or less	25 W or less	20 W or less	23 W or less	20 W or less	
	Rush Current	"a" to "i" *3	For 100 VAC: 20 A, 10 ms or less	For 24 VDC: 20 A, 2 ms or less	For 100 VAC: 20 A, 10 ms or less	For 100 VAC: 16 A, 6 ms or less	For 24 VDC: 20 A, 2 ms or less	For 24 VDC: 20 A, 1 ms or less	For 24 VDC: 20 A, 2 ms or less	For 24 VDC: 20 A, 1 ms or less
		"j" or later *3	For 200 VAC: 40 A, 10 ms or less	For 24 VDC: 30 A, 1 ms or less	For 200 VAC: 40 A, 10 ms or less	For 200 VAC: 32 A, 7 ms or less	For 24 VDC: 30 A, 1 ms or less		For 24 VDC: 30 A, 1 ms or less	
Withstand Voltage	AC external terminals to FG: 1500 VAC, 1 minute DC external terminals to FG: 500 VAC, 1 minute									
Insulation Resistance	500 VDC, 10 MΩ or above									
Physical Environment	Surrounding Air Temperature	0 °C to +50 °C *4								
	Storage Surrounding Air Temperature	-10 °C to +60 °C								
	Surrounding Air Humidity	85 % RH or less (without dew condensation, max. wet-bulb temperature: 39 °C or less)*5								
	Storage Surrounding Air Humidity	85 % RH or less (without dew condensation, max. wet-bulb temperature: 39 °C or less)*5								
	Altitude	2000 m or less								
	Atmosphere	No corrosive gas, no excessive dust, and no conductive dust								
Mechanical Working	Contamination Level *6	Contamination level: 2								
	Vibration Resistance	Vibration frequency: 10 to 150 Hz, acceleration: 9.8 m/s ² (1.0 G), half-amplitude: 0.075 mm, X, Y, Z: 3 directions for one hour								
Electrical Working Condition	Shock Resistance	Pulse shape: sine half wave, peak acceleration: 147 m/s ² (15 G), X, Y, Z: 3 directions six times each								
	Noise Resistance	Noise voltage: 1500 Vp-p, pulse width: 1 μs, rising time: 1 ns (Measured by using a noise simulator.)								
Electrical Working Condition	Static Electricity Discharge Resistance	Compliant with IEC61000-4-2, contact: 6 kV, air: 8 kV								

Item			V812		V810			V808	
			V812xS	V812xSD	V810xS V810xT	V810xC	V810xSD V810xTD	V810xCD	V808xSD
Mounting Conditions	Weight	"a" to "i" *3	Approx. 2.9 kg		Analog resistance film type V810xS/ V810xT: Approx. 2.5 kg V810xC: Approx. 2.2 kg Matrix resistance film type V810xT: Approx. 2.5 kg V810xC: Approx. 2.6 kg			Approx. 1.5 kg	
		"j" or later *3	Analog resistance film type Approx. 2.4 kg Matrix resistance film type Approx. 2.8 kg		V810xS/ V810xT: Approx. 2.1 kg				
	Dimen- sions W × H × D	"a" to "i" *3	326.4 × 259.6 × 69.0 mm		303.8 × 231.0 × 69.0 mm			233.0 × 178.0 × 65.8 mm	
		"j" or later *3						233.0 × 178.0 × 65.6 mm	
Panel Cut-out Dimensions		313.0 ^{+0.5} _{-0.5} × 246.2 ^{+0.5} _{-0.5} mm		289.0 ^{+0.5} _{-0.5} × 216.2 ^{+0.5} _{-0.5} mm			220.5 ^{+0.5} _{-0.5} × 165.5 ^{+0.5} _{-0.5} mm		
Case Color			Gray						
Material			PC/ABS resin						

- *1 The hardware version "a" to "i" is only approved. For more information on the hardware version, refer to page 7-3.
- *2 Use the Class 2 power supply for the 24-VDC power unit.
- *3 This is the hardware version for the V8 unit. For more information on the hardware version, refer to page 7-3.
- *4 Surrounding air temperature is 0 °C to + 45 °C when applying for UL listing using V810 series, hardware version "j" or later.
- *5 Use MONITOUCH in the environment whose wet-bulb temperature is 39 °C or less. Otherwise, MONITOUCH may be damaged.
- *6 This is an index that expresses the degree of conductive contamination in the environment where MONITOUCH is used.
"Contamination level 2" indicates the condition where only non-conductive contamination occurs. However, due to condensation, temporary conductive contamination may occur.

About UL/cUL Approval

The V8 series (DC power supply type) is UL/cUL-approved.

(File No.: E313548 (UL508), File No.: E315977 (UL1604))

The V8 series conforms to the following four standards.

- UL 508 : Industrial Control Equipment
- UL1604 : Electrical Equipment for Use in Class I, Division 2 Hazardous Locations
- CSA-C22.2 : No. 142-M1987 Process Control Equipment
- CSA-C22.2 No. 213-M1987 : Non-Incendive Electrical Equipment for Use in Class I, Division 2 Hazardous Locations

UL1604/CSA-C22.2 No. 213 Compliance and Handling Cautions

- Power, input and output wiring must be in accordance with Class I, Division 2 wiring methods - Article 501 - 10(B) of the National Electrical Code, NFPA 70.
- This product is certified for use in Class I, Division 2, Groups A, B, C or D hazardous location or non-hazardous locations.
- WARNING: Explosion Hazard: Substitution of components may impair compliance to Class I, Division 2.
- WARNING: Explosion Hazard: Do not disconnect the device while the circuit is alive unless area is known to be non-hazardous. Perform system set-up or diagnostics of the CF card port, USB-A and USB-B port only in a non-hazardous location.
- WARNING: Explosion Hazard: For use in a hazardous location, turn off the power before replacing or wiring modules.
- Do not replace a battery in a hazardous location.
- In the case of use in a hazardous location, be sure to check that the externally connected unit and each interface have been secured with screws or have been locked. In a hazardous location, it is impossible to insert or remove a cable from the applicable port. Be sure to check that the location is non-hazardous before inserting or removing it.

UL Listing Application for a System Equipped with the V8 Series

- The back panel of the V8 series is not approved as an enclosure. For UL listing application, build the V8 series in the system, and configure an enclosure so that the entire system will be UL-approved.
- Use the V8 series indoors only.
- For use on a flat surface of a type 1 enclosure
- In the case of the V812/V810 series, use a UL-approved crimp-style terminal for wiring of the power supply cable.

Model	Terminal Screw		Power Cable
	Screw Size	Tightening Torque	
V812/V810	M3.5	0.8 N•m	AWG16 - 18

- In the case of the V808 series, use naked wires for wiring of the power supply cable.

Model	Terminal Screw		Power Cable
	Screw Size	Tightening Torque	
V808	M3.5	0.8 N•m	AWG14 - 16

- Use the Class 2 power supply for the 24-VDC power unit.

CE Marking

- The V8 series (DC power supply type) complies with the following EMC Directives: EN61000-6-2, EN61000-6-4
- The V8 series is identified as a class-A product in an industrial environment. In the case of usage in a domestic environment, the V8 series is likely to cause electromagnetic interference. Appropriate preventive measures should be taken.

Installation Specifications

Item		Specifications
Grounding		Less than 100Ω, FG/SG separated
Protection Structure	Front Panel ^{*1}	Compliant with IP65 (when using waterproof gasket) ^{*2}
	Rear Case	Compliant with IP20
Cooling System		Cooling naturally
Structure		Inserted in a mounting panel
Appropriate Mounting Panel Thickness		1.5 to 5 mm

*1 Protection structure for the front when the V8 series is mounted on the mounting panel

*2 It is recommended to use the mounting panel whose thickness (steel, stainless) is 3.0 mm or more to keep the unit compliant with IP65. The strength differs depending on the material of the mounting panel. Check the environment where the V8 series is used.

Display Specifications

Item	V812xS	V810xS	V810xT/ V810xC	V808xS	V808xC
Display Device	TFT color				
Display Size	12.1-inch	10.4-inch		8.4-inch	
Colors	65,536 colors (without blinks) / 32,768 colors (with blinks)				
Display Resolution (W × H)	800 × 600 dots		640 × 480 dots	800 × 600 dots	640 × 480 dots
Dot Pitch (W × H)	0.3075 × 0.3075 mm	0.264 × 0.264 mm	0.33 × 0.33 mm	0.213 × 0.213 mm	0.267 × 0.267 mm
Backlight	Cold cathode tube				
Backlight Life (average life of backlight only)	Approx. 50,000 hours (at the normal temperature of 25°C)				
Backlight Auto OFF Function	Always ON, random setting				
Brightness Adjustment	Function switch: 3 levels / Macro: 128 levels				
Surface Sheet Material	Polycarbonate, 0.3 mm thick				
POWER Lamp	ON: Normal (green) Blink: Backlight error				

Touch Switch Specifications

Item	Analog Resistance Film Type	Matrix Resistance Film Type
Number of Switches	1024 × 1024	12-inch: 50 × 30 10-inch: 40 × 24
Mechanical Life	One million activations or more	
Surface Treatment	Hard-coated, anti-glare treatment 5%	

Function Switch Specifications

Item	Specifications
Number of Function Switches	8 pcs.
Method	Matrix resistance film type
Mechanical Life	One million activations or more

Interface Specifications

Item		Specifications	
D-sub 9-pin (CN1)	Applicable Standards	RS-232C, RS-422/485	
	Synchronization	Asynchronous type	
	Data Length	7- or 8-bit	
	Parity	None, odd, even	
	Stop Bit	1- or 2-bit	
	Baud Rate	4800, 9600, 19200, 38400, 57600, 76800, 115k bps (187500 bps for MPI connection*)	
	Applications	PLC, temperature controller, barcode reader, etc.	
Modular Jack 8-pin (MJ1/MJ2)	Applicable Standards	RS-232C, RS-485 (2-wire connection)	
	Applications	Screen data transfer (MJ1), PLC, temperature controller, CREC, barcode reader, V-I/O, Multi-link 2, V-Link, etc.	
USB Connector (USB-A/B)	USB-A	Applicable Standards	Compliant with USB version 1.1
		Baud Rate	Low speed: 1.5 Mbps, full speed: 12 Mbps
		Applications	Printer (EPSON STYLUS PHOTO series), USB-CFREC, keyboard, mouse, etc.
	USB-B	Applicable Standards	Compliant with USB version 1.1
		Baud Rate	Low speed: 1.5 Mbps, full speed: 12 Mbps
		Applications	Screen data transfer, PictBridge-compatible printer
Ethernet Port 100BASE-TX/10BASE-T (LAN)	Applicable Standards	Compliant with IEEE802.3u (100BASE-TX), IEEE802.3 (10BASE-T)	
	Baud Rate	10 Mbps, 100 Mbps	
	Recommended Cable	100Ω UTP (unshielded twist-pair cable), category 5, max. 100 m long	
	Applications	PLC connection, etc.	
CF Card Interface	Compliant with CompactFlash™		
Extensional Communication Port (CN5)	SX Bus, T-Link, Ethernet, CC-Link, PROFIBUS-DP, DeviceNet, etc. (The communication interface unit "CU-xx" is necessary.)		
Optional Unit Port (CN7)	RGB input/output, video, sound (The optional unit "GU-xx" is necessary.)		

* For details, refer to the V8 Series Connection Manual.

Clock and Backup Memory Specifications

Item	Specifications	
	V812xS/ V810xS/ V810xT/ V810iC/ V808xS/ V808iC	V810C/ V808C
Battery Specification	Coin-type lithium primary cell	
Backup Memory	SRAM 512 kbytes	SRAM 128 kbytes
Backup Period	5 years (ambient temperature at 25°C)	
Battery Voltage Drop Detection	Provided (internal memory of \$s167 allocated)	
Calendar Accuracy	Monthly deviation ±90 sec (ambient temperature at 25°C)*	

* Time loss is approximately 90 seconds a month in an ambient temperature of 25°C in the non-energized state (backup with battery). Depending on the ambient temperature, the calendar may lose 356 seconds or advance 189 seconds in a month at the maximum. Correct the clock periodically.

Drawing Environment

Item	Specifications
Drawing Method	Exclusive configuration software
Drawing Tool	Name of exclusive configuration software: V-SFT-5 Personal computer: Pentium III 800 MHz or above (Pentium IV 2.0 GHz or above recommended) OS: Windows98SE/NT4.0/Me/2000/XP/XP64 Edition/ Vista 32-bit Capacity of hard disk required: Free space of approx. 850 Mbytes or more Memory: 512 Mbytes or more Display: Resolution 1024 × 800 or above Screen color: 16 bits or more

Display Function Specifications

Item		Specifications				
Interface Language*		Japanese	English/Western Europe	Chinese (Traditional)	Chinese (Simplified)	Korean
Characters	1/4-size, 1-byte	ANK code	Latin 1	ASCII code	ASCII code	ASCII code
	2-byte 16-dot	JIS #1, 2 levels	–	Chinese (traditional)	Chinese (simplified)	Hangul (without Kanji)
	2-byte 32-dot	JIS #1 level	–	–	–	–
Font		Windows font Stroke font				
Character Size	1/4-size	8 × 8 dots				
	1-byte	8 × 16 dots				
	2-byte	16 × 16 dots or 32 × 32 dots				
	Enlargement Factor	X: 1 to 8 times, Y: 1 to 8 times Point*2: 8, 9, 10, 11, 12, 14, 16, 18, 20, 22, 24, 26, 28, 36, 48, 72				
Number of Displayable Characters	Display Resolution	800 × 600			640 × 480	
	1/4-size	100 characters × 75 lines			80 characters × 60 lines	
	1-byte	100 characters × 37 lines			80 characters × 30 lines	
	2-byte	50 characters × 37 lines			40 characters × 30 lines	
Character Properties	Display properties	Normal, reverse, blink, bold, shadow, transparent				
	Colors	65,536 colors (without blinks) / 32,768 colors (with blinks)				
Graphics	Lines	Line, continuous line, box, parallelogram, polygon				
	Circles	Circle, arc, sector, ellipse, elliptical arc				
	Others	Tile patterns				
Graphic Properties	Line types	6 (thin, thick, dot, chain, broken, two-dot chain)				
	Tile patterns	16 (incl. user-definable 8 patterns)				
	Display properties	Normal, reverse, blink				
	Colors	65,536 colors (without blinks) 32,768 colors (with blinks)				
	Color selection	Foreground, background, boundary (line)				

*1 In addition, the following fonts are available.
 Gothic, English/Western Europe HK Gothic, English/Western Europe HK Times, Central Europe, Cyrillic, Greek, Turkish

For more information, refer to the V8 Series Reference Manual.

*2 Applicable when Gothic font, Windows font or stroke font is used.

Function Performance Specifications

Item	Specifications	
	V812xS/ V810xS/ V810xT/ V810iC/ V808xS/ V808iC	V810C/ V808C
Screens	Max. 1024	
Screen Memory (Flash memory)	Approx. 12.5 Mbytes (varies depending on the font)	Approx. 4.5 Mbytes (varies depending on the font)
Switch	1024 per screen	
Switch Actions	Set, reset, momentary, alternate, to light (Possible to press a function switch and a switch on the display at the same time)	
Lamp	Reverse, blink, exchange of graphics 1024 per screen	
Graph	Pie, bar, panel meter and closed area graph: No limitation Statistics and trend graphs: Max. 256 per layer ^{*2}	
Data Setting	Numerical Data Display	No limitation
	Character Display	No limitation
	Message Display	Display Resolution: 800 × 600: Max. 100 characters (1-byte) 640 × 480: Max. 80 characters (1-byte) No limitation
Sampling	Sampling display of buffer data (Constant sampling, bit synchronization, alarm logging, time order alarming, alarm function)	
Graphic Library	Max. 2560	
Overlap Library	Max. 1024	
Data Blocks	Max. 1024	
Messages	Max. 32768 lines	
Patterns	Max. 1024	
Macro Blocks	Max. 1024	
Page Blocks	Max. 1024	
Direct Blocks	Max. 1024	
Screen Blocks	Max. 1024	
Data Sheets	Max. 1024	
Screen Library	Max. 1024	
Comments	Max. 32767	
Device Memory Map	Max. 32 × 8 (PLC1 to PLC8)	
Time Display	Provided	
Hard Copy	Provided	
Buzzer	Provided, 2 sounds (short beep, long beep)	
Auto OFF Function	Always ON, random setting	
Self-diagnostic Function	Switch self-test function Communication parameter setting check function Communication check function	

*1 The number of setting memory locations is limited to 1024 per screen.

*2 Layer: 4 per screen (base + 3 overlap displays)

2. Dimensions and Panel Cut-out

External Dimensions and Panel Cut-out Dimensions for V812S / V812iS

- Front View

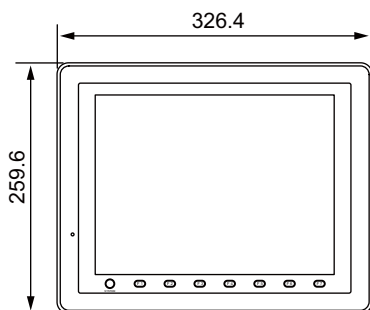

- Panel Cut-out Dimensions

(Unit: mm)

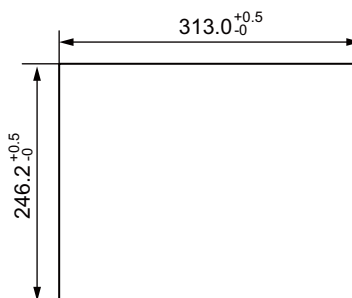

Hardware version : a to i

- Rear View

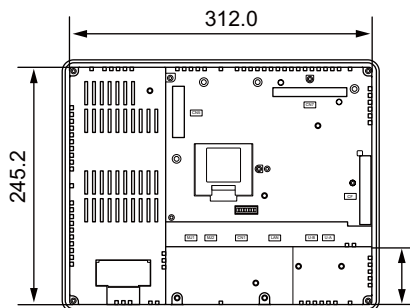

- Side View

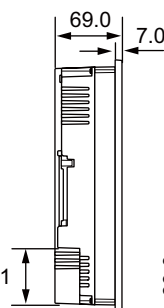

- Bottom View

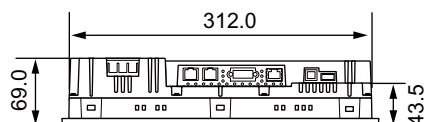

Hardware version : j or later

- Rear View

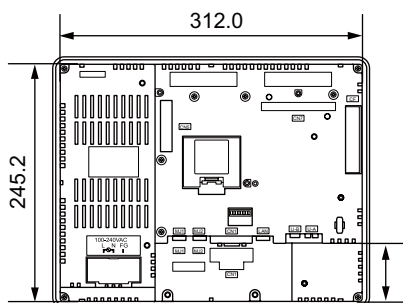

- Side View

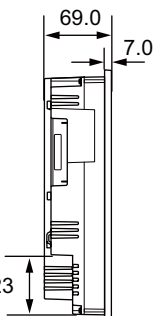

- Bottom View

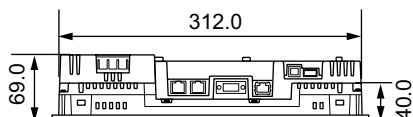

* For more information on the hardware version, refer to page 7-3.

External Dimensions and Panel Cut-out Dimensions for V810S / V810iS / V810T / V810iT

- Front View

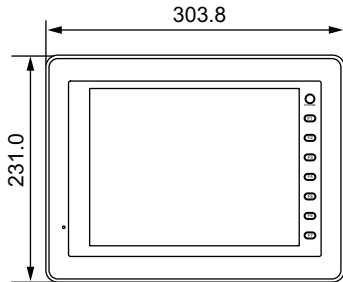

- Panel Cut-out Dimensions

(Unit: mm)

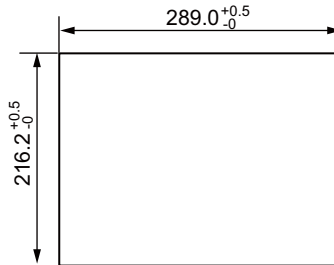

Hardware version : a to i

- Rear View

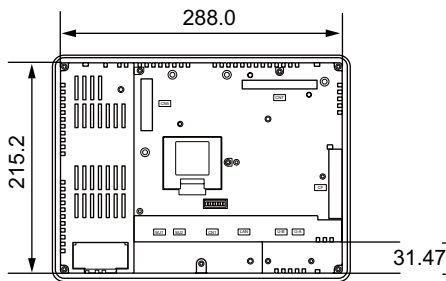

- Side View

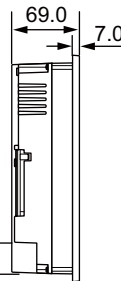

- Bottom View

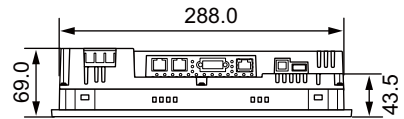

Hardware version : j or later

- Rear View

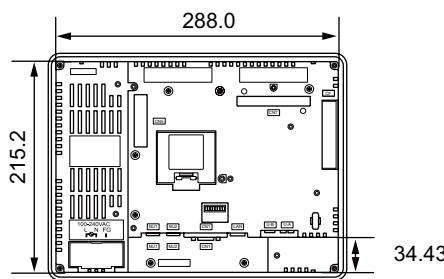

- Side View

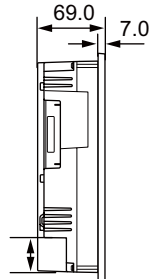

- Bottom View

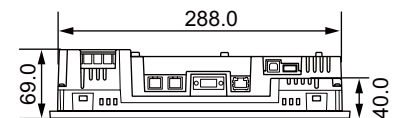

* For more information on the hardware version, refer to page 7-3.

External Dimensions and Panel Cut-out Dimensions for V810C / V810iC

- Front View

(Unit: mm)

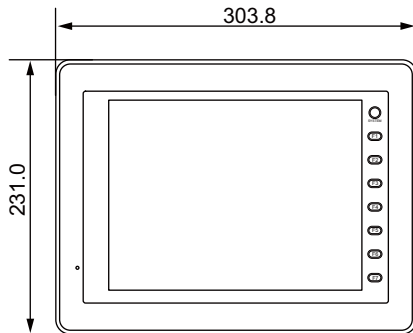

- Rear View

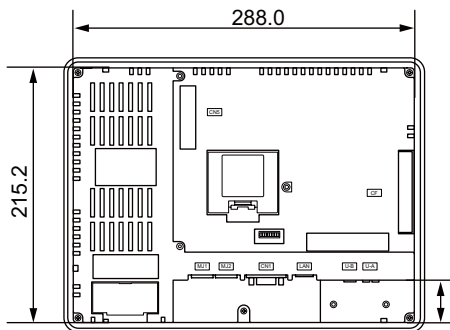

- Side View

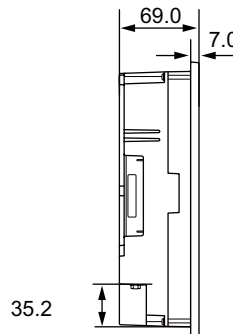

- Bottom View

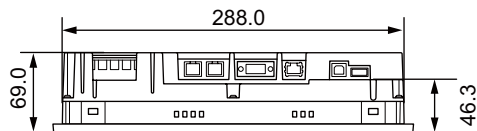

- Panel Cut-out Dimensions

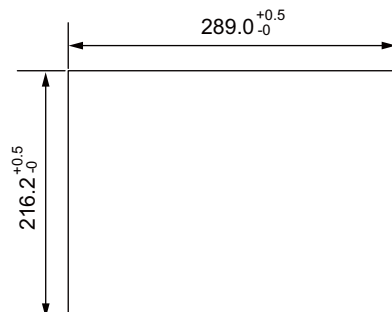

External Dimensions and Panel Cut-out Dimensions for V808S / V808iS

• Front View

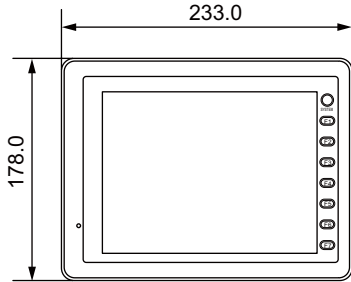

• Panel Cut-out Dimensions

(Unit: mm)

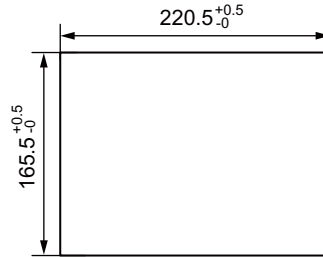

Hardware version : a to i

• Rear View

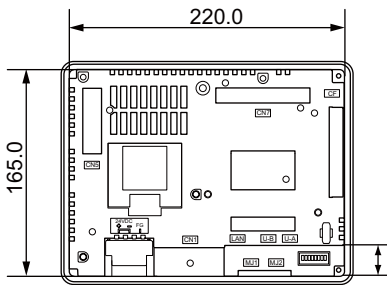

• Side View

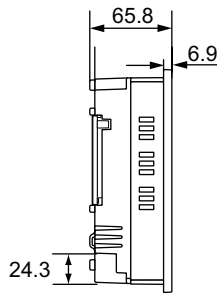

• Bottom View

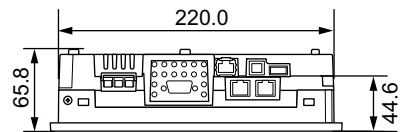

Hardware version : j or later

• Rear View

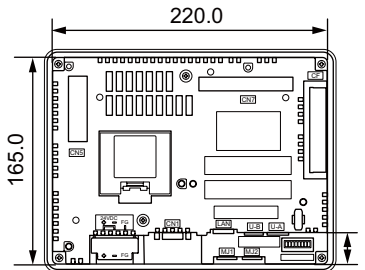

• Side View

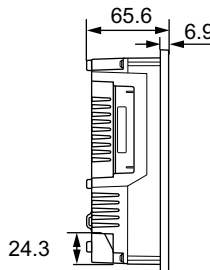

• Bottom View

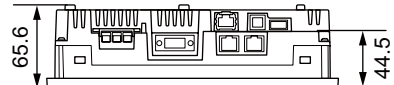

* For more information on the hardware version, refer to page 7-3.

External Dimensions and Panel Cut-out Dimensions for V808C / V808iC

- Front View

(Unit: mm)

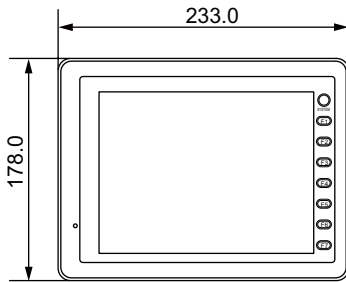

- Rear View

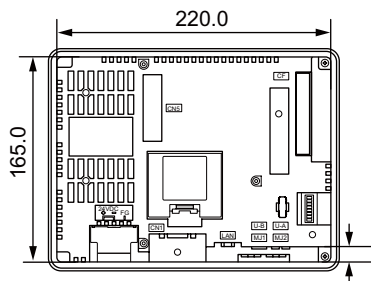

- Side View

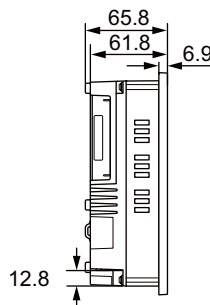

- Bottom View

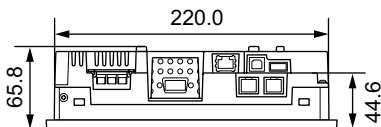

- Panel Cut-out Dimensions

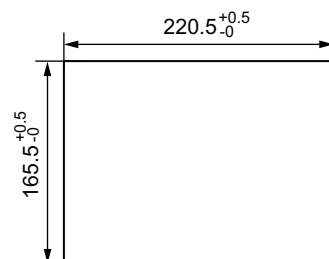

3. Names and Functions of Components

V812S / V812iS

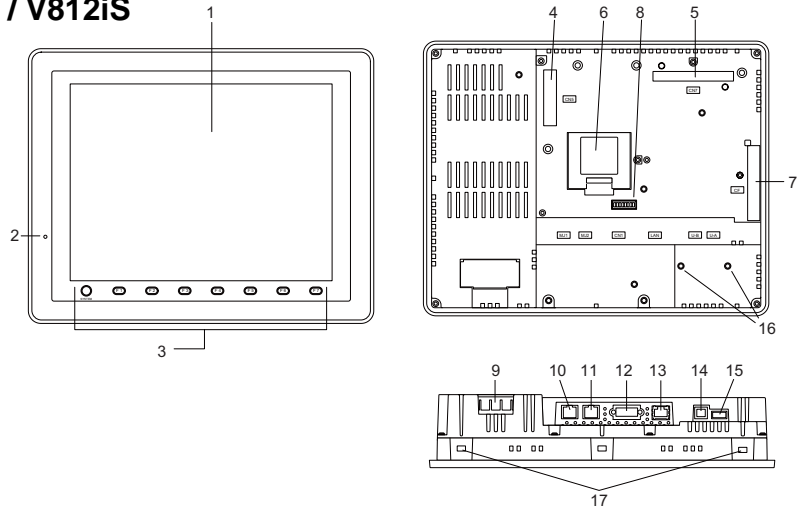

V810S / V810iS / V810T / V810iT

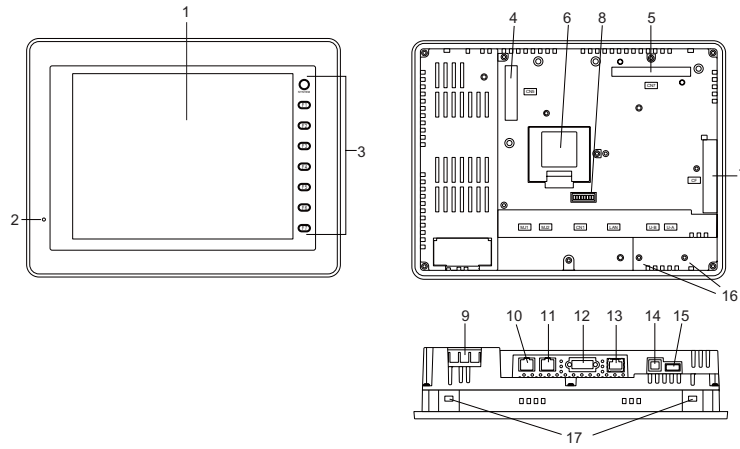

V810C / V810iC

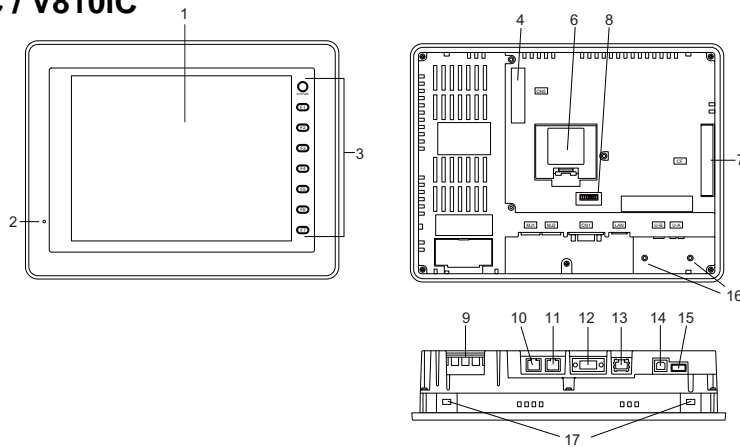

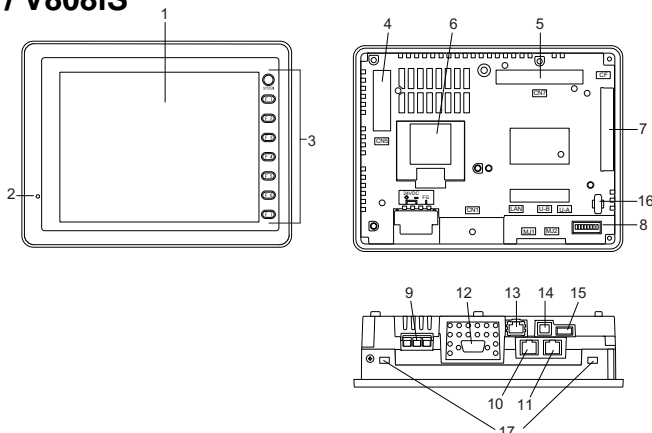
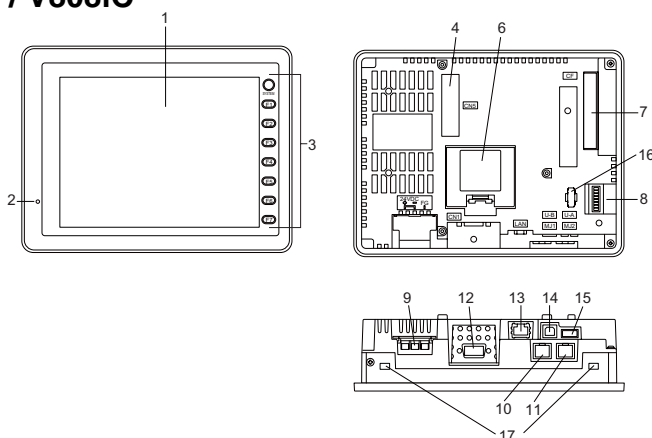
V808S / V808iS**V808C / V808iC**

1. Display
This is the display unit.
2. Power lamp (POWER)
Illuminates in green when the V8 series is powered on, and is operating normally. Flashes when an error occurs to the backlight (burned-out backlight, etc.).
3. Function keys
Used for RUN/STOP selection, brightness adjustment and backlight ON/OFF (setting on the V-SFT-5 editor required). These switches can be used as user-defined switches in the RUN mode.
4. Communication interface unit connector (CN5)
This is the connector where the communication unit ("CU-xx", optional) for OPCN-1, T-LINK, CC-Link, Ethernet, PROFIBUS-DP, SX Bus or DeviceNet is mounted.
5. Optional unit connector (CN7) V812iS/V810iS/V810iT/V808iS only
Used for mounting the optional unit "GU-xx" for video input, sound output, RGB input or RGB output.
6. Battery holder
Contains a backup battery for SRAM and clock.
When the battery voltage drops, replace the battery with a new one (V7-BT).
7. CF card connector (CF)
This is the connector where the CF card is inserted. Access to the CF card is enabled when the cover is closed.

8. DIP switch
8-bit DIP switch used for setting terminating resistance of the CN1 signal line and the MJ1/MJ2 RS-485 signal line.
9. Power supply terminal block
Supplies the power to the V8 series (100 to 240 VAC, 24 VDC).
10. Modular jack 1 (MJ1)
Used for screen data transfer and connection with PLCs or other peripheral devices.
11. Modular jack 2 (MJ2)
Used for connection with PLCs or other peripheral devices.
12. PLC communication connector (CN1)
Used for connection with a controller (PLC, temperature controller, inverter, etc.).
13. 100BASE-TX/10BASE-T connector (LAN) V8i/V8iC series only
Used for Ethernet connection.
14. USB-B (slave port)
Used for screen data transfer or connection with a PictBridge-compatible printer.
15. USB-A (master port)
Used for connection with a printer, a USB CF card recorder "USB-CFREC", keyboard, mouse etc.
16. USB cable clamp mounting hole
For V810/V812, this hole is used for attaching a USB cable clamp.
For V808, this hole is used for attaching a USB cable tie.
17. Mounting holes
Used for inserting fixtures when securing the V8 series to the mounting panel.

4. Serial Connector (CN1)

Connector for a Controller

Communication (RS-232C, RS-422/485) with a controller is enabled via the serial connector (CN1).

- For V812/V810
- For V808

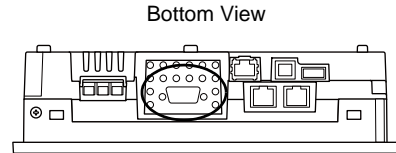
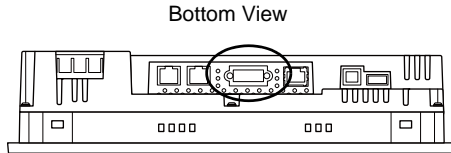

The serial connector pins correspond to signals as given below.

CN1 (D-sub 9-pin, female)				
Pin No.	RS-232C ^{*1}		RS-422 / RS-485 ^{*1}	
	Signal	Contents	Signal	Contents
1	NC	Not used	+RD	Receive data (+)
2	RD	Receive data	-RD	Receive data (-)
3	SD	Send data	-SD	Send data (-)
4	NC	Not used	+SD	Send data (+)
5	SG	Signal ground	SG	Signal ground
6	NC	Not used	+RTS	Request to send (+)
7	RTS	Request to send	-RTS	Request to send (-)
8	CTS	Clear to send	NC	Not used
9	NC	Not used	+5V	Use prohibited ^{*2}

^{*1} The signal level can be changed between RS-232C and RS-422/485 on the configuration software. When RS-232C is selected, set the DIP switches 5 and 7 to the OFF position. (For more information on the DIP switch, refer to "Chapter 4".)

^{*2} When RS-422/485 is selected, +5V is output from pin No. 9. +5V is used as the power supply for the external terminating resistance for RS-422/485 communication. It cannot be used as an external power supply.

Recommended Connector

The following connector is recommended for a self-made cable.

Recommended connector	DDK's 17JE-23090-02(D8C)-CG	D-sub 9-pin / male / inch screw thread (#4-40UNC) type / with hood / lead- and cadmium-free
-----------------------	-----------------------------	---

PLC/Temperature Controller Connection

The V8 series can communicate with PLC or temperature controller.

For more information about the connectable device models and the setting on V-SFT-5, refer to the "V8 Series Connection Manual".

Barcode Reader Connection

The V8 series can receive the barcode data from the connected barcode reader. For more information about the connectable device models and the setting on V-SFT-5, refer to the "V8 Series Connection Manual".

5. Modular Jack (MJ1 / MJ2)

Modular Jack 1 (MJ1) / 2 (MJ2)

A screen data transfer cable (MJ1 only), temperature controller, barcode reader, CREC, or V-I/O can be connected to the modular jack (MJ1 or MJ2).

- For V812/V810

Bottom View

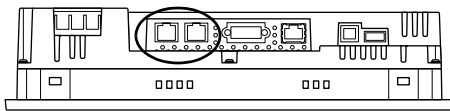

- For V808

Bottom View

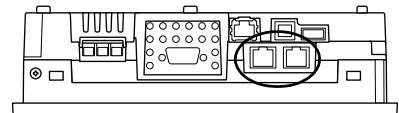

Pins of MJ1 and MJ2 correspond to signals as given below.

MJ1/2	Pin No.	Signal	Contents
	1	+SD/RD	RS-485 + data
	2	-SD/RD	RS-485 - data
	3	+5V	Externally supplied +5 V ^{*1}
	4	+5V	
	5	SG	Signal ground
	6	SG	
	7	RD	RS-232C receive data
	8	SD	RS-232C send data

- *1 Allowable current for the external power supply +5V at MJ1/MJ2/USB-A of the V8 series
- For MJ1 and MJ2, the maximum allowable current is 150 mA in total.
 - When connecting an optional unit or communication unit, be careful not to exceed the total allowable current for USB-A, MJ1 and MJ2.

Type	Optional Unit	Communication Unit (CU-xx)	Allowable Current (MJ1 + MJ2 + USB-A)
V812xS / V810xS V810xT / V808xS	None	None	650 mA
		Provided	
V812iS / V810iS V810iT / V808iS	GU-00 - GU-03	None	550 mA
		Provided	650 mA
	GU-10 / GU-11	None	250 mA
		Provided	250 mA
V810xC / V808xC	-	None	500 mA
		Provided	150 mA

Combined Use of MJ1 and MJ2 Functions

Multi-link 2 and ladder transfer function cannot be used at the same time.

PLC/Temperature Controller Connection

The V8 series can communicate with PLC or temperature controller.

For more information about the connectable device models and the setting on V-SFT-5, refer to the “V8 Series Connection Manual”.

Transferring Screen Data

When transferring screen data, use Hakko Electronics' data transfer cable (V-CP: 3 m) to connect MJ1 of the V8 series to a personal computer.

* Screen data can be transferred via Ethernet or using a CF card in addition to serial transfer.

Connection Example

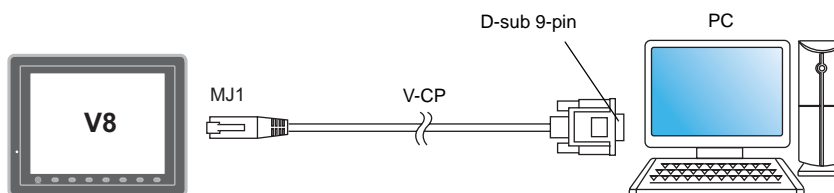

* When [MJ1] is selected for [No Connection] on the V-SFT editor, it is possible to transfer data in the RUN mode because the RUN/STOP mode (on the Main Menu screen) can be automatically selected. Also, the RUN/STOP mode is automatically selected when the difference program transfer and the simulator are used.

When an option other than [No Connection] is selected for [MJ1], select the STOP mode (on the Main Menu screen) and transfer screen data. Simulation or Difference Program Transfer is not available.

V-SFT-5 Setting

Select [File] → [Transfer] → [Communication Setting], and select “Serial Port” for [Communication Port] in the [Communication Setting] window.

Barcode Reader Connection

The V8 series can connect to the barcode reader at the MJ1/2 of the V8 series with Hakko Electronics' optional cable (V6-BCD: 3 m), and receive the barcode data from it. For more information about the connectable device models and the setting on V-SFT-5, refer to the “V8 Series Connection Manual”.

Printer Connection (Serial Printer)

The printer for the serial interface is connected with the MJ1/2 port of the V8 series, and it is possible to print.

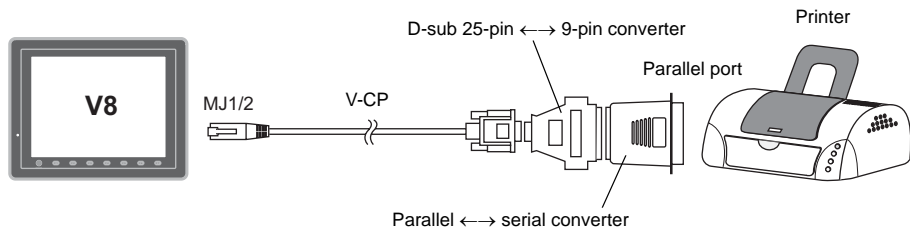

- *1 Refer to the specification sheet of the printer to be used for the connecting cable for serial interface. For information on MJ1/MJ2 signals, refer to page 2-17.
- *2 To connect to a printer equipped with a parallel interface, use a commercially available parallel-serial converter. When the serial connector of the converter is a D-sub 9-pin male connector, use Hakko Electronics' V-CP connection cable.

Compatible Printer Models

Editor Setting*	Applicable Models	Port
PR201 Monochrome	PC-PR201 series models with which printing from MS-DOS is possible	MJ1/MJ2
PR201 Color		
ESC-P Monochrome	ESC/P24-J84, ESC/P-J84, ESC/P Super models with which printing from MS-DOS is possible	
ESC-P Color		
CBM292 / 293	Citizen CBM Line Thermal Printer (Hard copy is not possible)	
MR - 400	Sato barcode printer MR-400 Series (Hard copy, data sheet print, and sample print are not possible.)	
EPSON STYLUS PHOTO	EPSON Color Inkjet Printer STYLUS PHOTO (Hard copy print in 32k colors is possible.)	
EPSON STYLUS C86 Series	EPSON Color Inkjet Printer STYLUS C86 (Hard copy print in 32k colors is possible.)	
EPSON STYLUS C65 Series	EPSON Color Inkjet Printer STYLUS C65 (Hard copy print in 32k colors is possible.)	

* For more information on the printer that can be connected to the V8 series, visit our website (http://www.hakko-elec.co.jp/index_e.html).

V-SFT-5 Setting

Select [System Setting] → [Device Connection Setting] → [Others] → [Printer], and select a desired printer type for [Type] and "MJ1/2" for [Connect to:] in the [Printer] tab window. Also, set the baud rate etc. in the [Serial Port] tab window.

6. USB Connector

USB-A (Master Port)

A printer, USB-CFREC, keyboard, mouse or USB hub can be connected via USB-A.
The USB port on the V8 unit is compliant with USB 1.1.

- For V812/V810

Bottom View

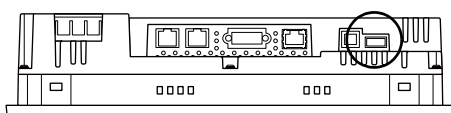

- For V808

Bottom View

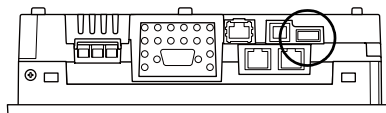

Enlarged View



Printer

Screen hard copy, historical data or data sheet can be printed out from the printer connected to the V8 series.

Connection Example

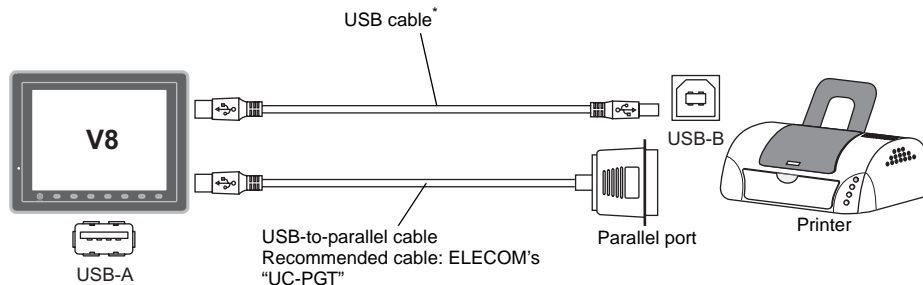

* Use a cable included as an accessory of the printer.

Available Printer

Model*	Port on the Printer Side	Cable
PR 201 ESC-P	Parallel port	UC-PGT
EPSON STYLUS PHOTO EPSON STYLUS C86 EPSON STYLUS C65	Parallel port	UC-PGT
	USB-B	USB cable

* For more information on the printer that can be connected to the V8 series, visit our website (http://www.hakko-elec.co.jp/index_e.html).

V-SFT-5 Setting

Select [System Setting] → [Device Connection Setting] → [Others] → [Printer], and select a desired printer type for [Type] and "USB-A" for [Connect to:] in the [Printer] tab window.

USB CF Card Recorder (USB-CFREC)

Screen data or historical data can be transferred and saved on the CF card by connecting a USB-CFREC to the V8 series.

Connection Example

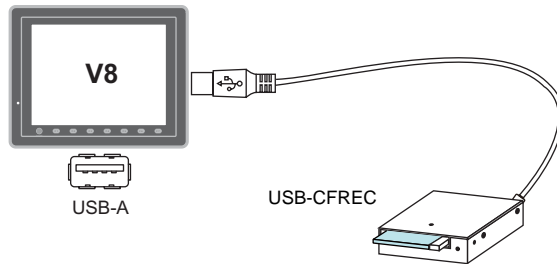

V-SFT-5 Setting

Select [USB Port] for the CF card connecting port in the [System Setting] → [CF Card Setting] dialog.

Barcode

Barcode data can be read via the USB barcode connected to the V8 series.

Connection Example

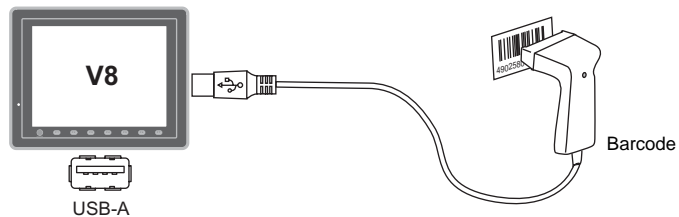

Available Barcode

- Barcode reader in compliance with USB-HID can be connected.
- For details on the barcode reader which has been verified by Hakko Electronics, visit our website (http://www.hakko-elec.co.jp/index_e.html).

V-SFT-5 Setting

Select [USB A] for the Barcode connecting port in the [System Setting] → [Device Connection Setting] → [PLC n : Barcode] dialog.

Keyboard

Numerical data or characters can be entered by using the USB keyboard or the USB keypad connected to the V8 series.

Connection Example

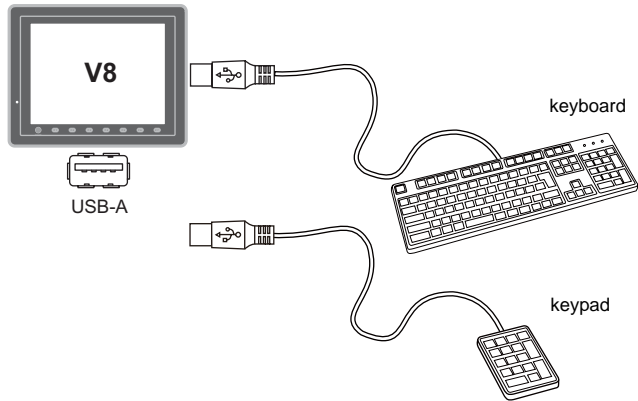

Available Keyboard

Type	Detail
Japanese specification	106 keyboard, 109 keyboard
US specification	101 keyboard, 104 keyboard
Keypad	

V-SFT-5 Setting

It is necessary to register the [Entry] icon on the screen. It is also necessary to set the numerical display or character display of [Display Function: Entry Target]. For details, refer to the "V8 series Reference Additional Functions".

V8 Setting

Select a keyboard type on the Main Menu screen. For details, refer to the "Keyboard Selection" (page 5-44).

Mouse

Screen operation is possible by using the USB mouse connected to the V8 series.

Connection Example

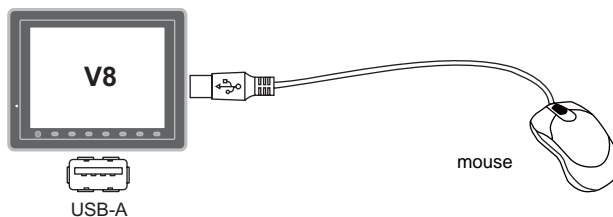

For details, refer to the "V8 series Reference Additional Functions".

USB Hub

A printer and a USB-CFREC etc. can be used at the same time by using a USB hub to the V8 series.

Connection Example

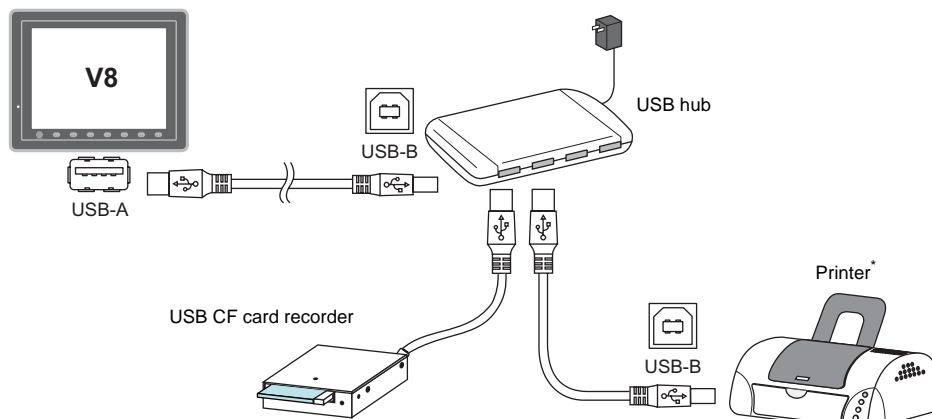

* The parallel printer can also be connected. (In this case, the parallel printer which can be used on the V8 series and a commercially available parallel-to-USB cable (ELECOM's UC-PGT recommended) must be used. For more information on the printer that can be connected to the V8 series, visit our website (http://www.hakko-elec.co.jp/index_e.html).

Recommended USB Hub (Operations Verified)

The operations of the USB hubs shown below are verified.

Manufacturer	Model	Remarks*
ELECOM	U2H-Q4SBS	USB 2.0 compatible
ELECOM	UH-A4SID	USB 1.1 compatible
Arvel	H415US2-LV	USB 2.0 compatible
Arvel	H413US-BL	USB 1.1 compatible

* USB2.0-compatible hub can be connected; however, it works as USB 1.1 because the USB port on the V8 unit is compliant with USB 1.1.

V-SFT-5 Setting

Refer to "V-SFT-5 Setting" on page 2-20 for the printer, page 2-21 for the USB-CFREC, page 2-21 for the barcode and page 2-22 for the keyboard.

Notes

- A barcode reader and a keyboard cannot be used via a USB hub at the same time.
- Two or more barcode readers or keyboards cannot be used via a USB hub at the same time.
- A maximum of two USB hubs can be connected (cascaded) to the V8 unit.
Note that the performance will be decreased more when two USB hubs are connected.
- Do not turn off the power adaptor or disconnect the connector between the power adaptor and the USB hub when the USB hub is connected to the V8 unit and is activated by its power adaptor. Doing so may cause insufficient power supply to the V8 unit resulting in faulty operation such as repeated restarting.
- When connecting two USB hubs to the V8 unit, supply the power to the USB hub using the adaptor included with the hub.
Even if connecting one USB hub, use the power supply adaptor included with the USB hub if provided.

USB-B (Slave Port)

Screen data can be transferred and the PictBridge-compatible printer can be connected via USB-B.

- For V812/V810

Bottom View

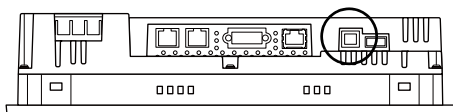

Enlarged View

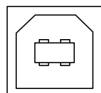

- For V808

Bottom View

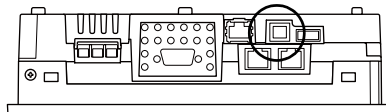

Printer (PictBridge)

Screen hard copy, historical data or data sheet can be printed out from the PictBridge-compatible printer.

Connection Example

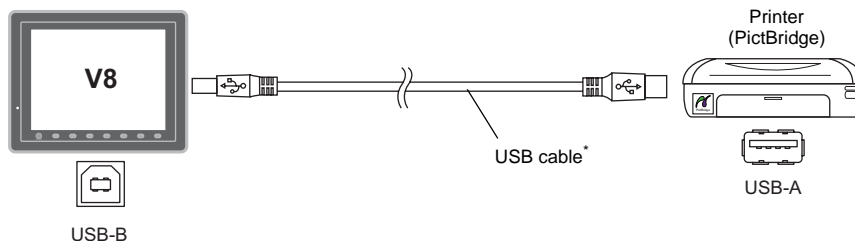

* Use a commercially available USB cable. It is recommended to use a shielded twist-pair USB cable of 5 m long.

Available Printer

Any PictBridge-compatible printer can be connected.

V-SFT-5 Setting

Select [System Setting] → [Device Connection Setting] → [Others] → [Printer], and select "PictBridge" for [Type] in the [Printer] tab window.

Transferring Screen Data

Screen data can be transferred via USB-B (USB slave port).

Be sure to install the dedicated USB driver for the V8 series on the computer. For the installation procedure, refer to "Installation Procedure of the Driver for Screen Data Transfer" on page 2-25.

Connection Example

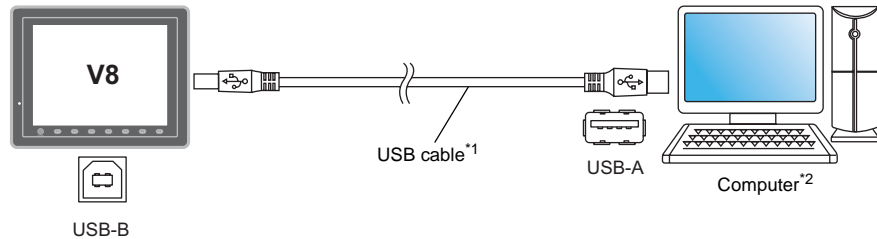

*1 Use a commercially available USB cable. It is recommended to use a shielded twist-pair USB cable of 5 m long.

*2 When using USB on Windows 98, Windows 98 Second Edition or later is required.

Installation Procedure of the Driver for Screen Data Transfer

The installation procedure on Windows XP is described as an example below.

1. Connect the USB-B port of the V8 series (with power on) to the computer (with power on) using a USB cable.
2. The message "Found New Hardware" and then the driver installation wizard appear on the computer. Select [No, not this time] and click the [Next] button.



3. The dialog below is displayed. Select [Install from a list or specific location], and click the [Next] button.

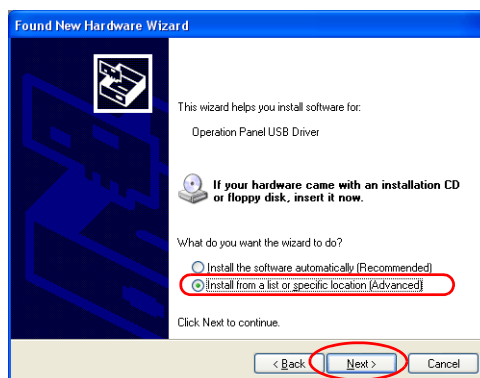

4. The following dialog is displayed. Select [Don't search. I will choose the driver to install.], and click the [Next] button.

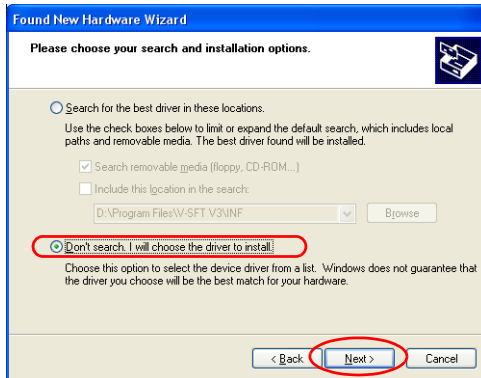

5. The dialog below is displayed. Click the [Next] button.

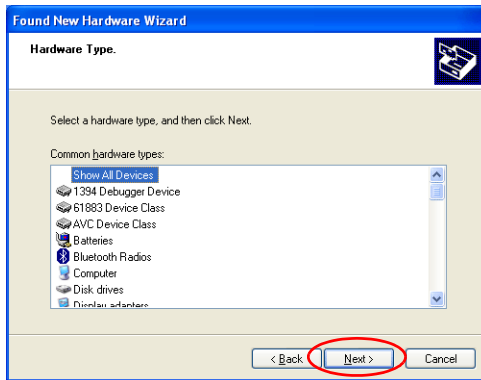

6. The following dialog is displayed. Click [Have Disk] button.

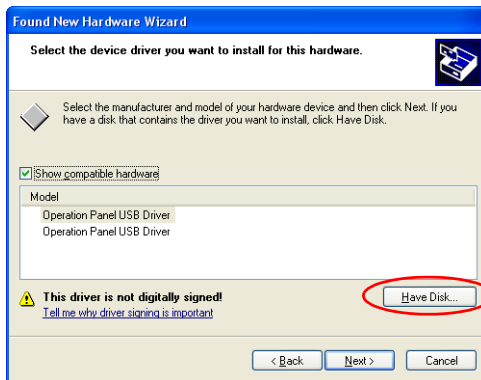

7. The [Install From Disk] dialog is displayed. Click the [Browse] button.

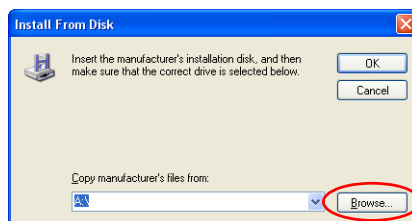

8. The USB driver "OP-U.inf" is automatically stored in the "INF" folder within the V-SFT-5 editor installation folder ("V-SFT V5" for example).



The USB driver to be installed varies, depending on the OS installed on your computer. Be sure that the driver is correct.

Select the "OP-U.inf" file that corresponds to OS of the personal computer and click the [Open] button.

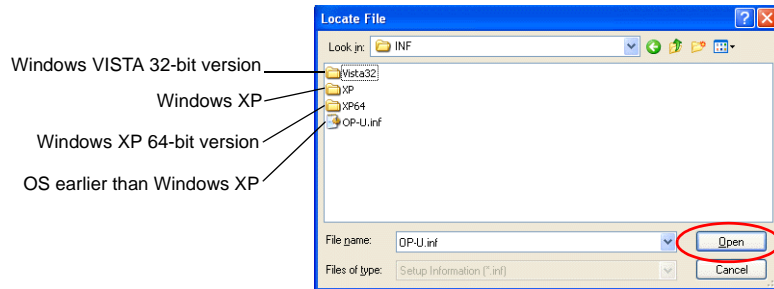

9. The previous dialog is displayed again. Check the path shown under [Copy manufacturer's files from:] and click the [OK] button.

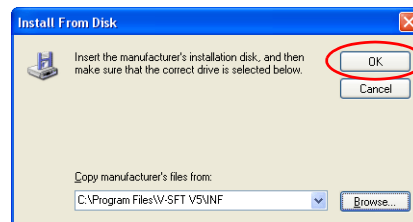

10. The following dialog is displayed. Check that [Operation Panel USB Driver] is shown under [Model]. Click the [Next] button.

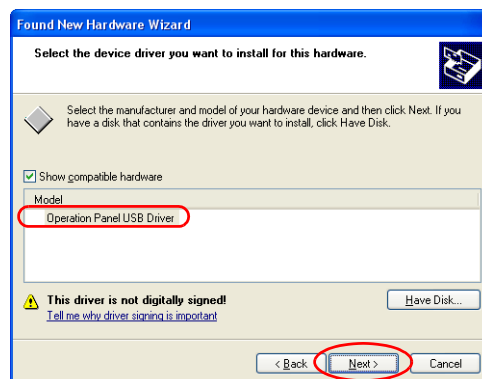

11. The driver installation starts.

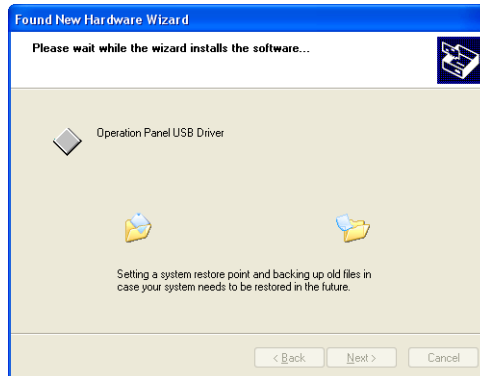

12. The dialog shown below is displayed on completion of installation. Click the [Finish] button.

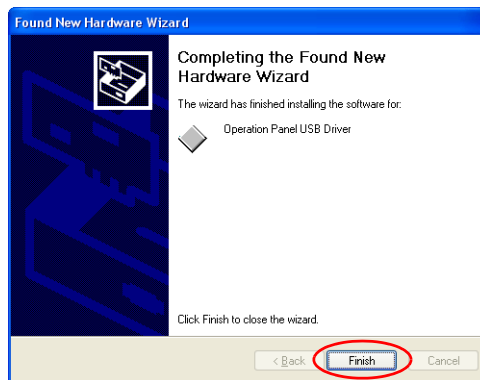

Recognition of USB Driver

When the driver has been installed successfully, the [Device Manager] window shows "Operation Panel - Operation Panel USB Driver".

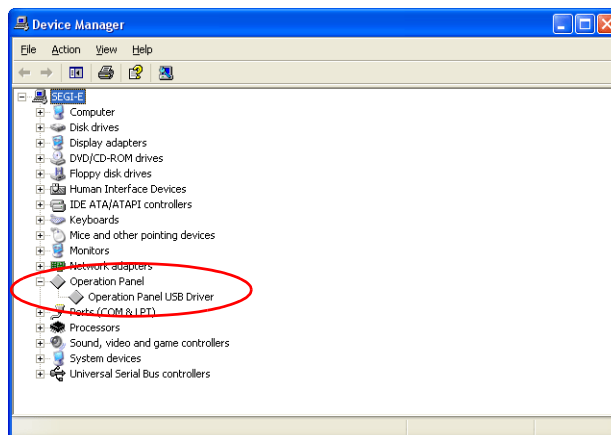



This will disappear when MONITOUCH and computer are disconnected.

If [Other Device] or [?] is shown even while their connection via USB is maintained, the USB driver is not recognized. If this happens, uninstall the USB driver and reinstall it.

Securing USB Cable

A USB cable may be disconnected from the V8 unit depending on the mounting condition. To avoid disconnection, use the USB cable clamp or cable tie supplied with the unit.

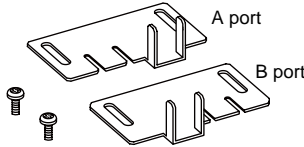
Components for USB Cable Fixation

V812 / V810 (Hardware version : "a" to "i")		V812 / V810 (Hardware version : "j" or later), V808	
M3 × 8 screws	2 pcs.	Cable tie	1 pce.
USB cable clamp for port A	1 pce.		
USB cable clamp for port B	1 pce.		
			

Securing USB Cable for V812 / V810 (Hardware version : "a" to "i")

1. Securing the clamp temporarily
Secure the USB cable clamps for port A and port B temporarily using two screws (M3 × 8). If using one USB cable, secure the cable clamp for the port to be used only.

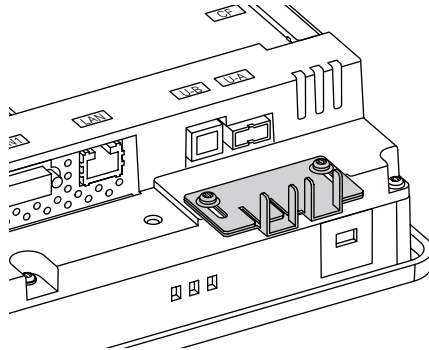

2. Inserting a USB cable and tightening with screws
Insert a USB cable to the port and slide the USB cable clamp in the direction of the arrow. Adjust the position of the cable clamp until it fits with the connector, and tighten screws. (Tightening torque: 0.5 to 0.8 N•m)

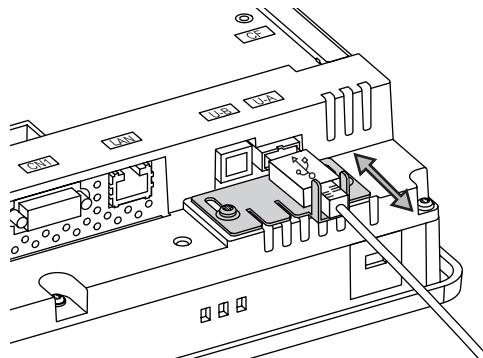

The following figure shows the case where only USB-B is used and the one where both USB-A and B are used.

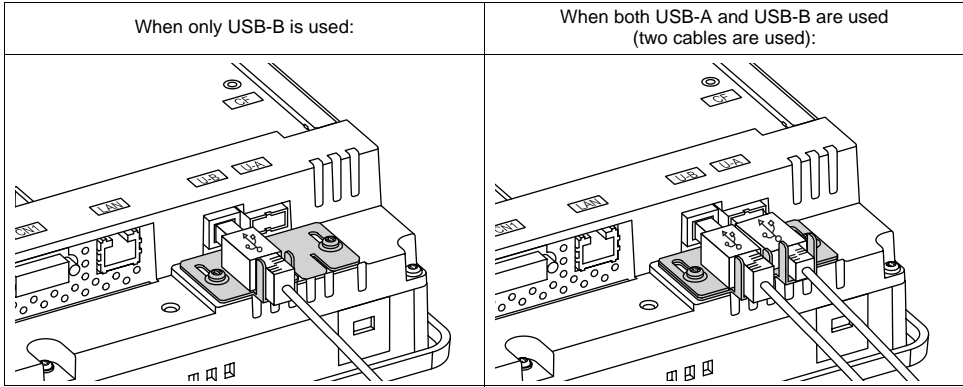

Securing USB Cable on V812 / V810 (Hardware version : "j" or later), V808

1. Having a cable tie
Draw a cable tie through the hole as shown in the figure below.

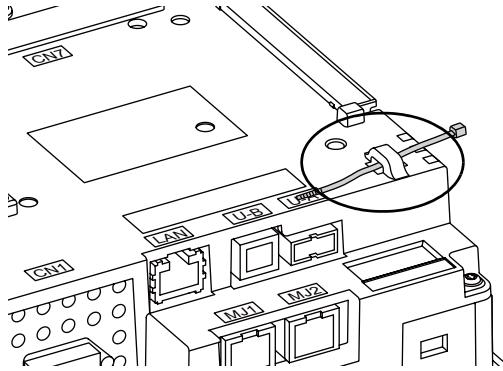

2. Inserting and securing a USB cable
Insert a USB cable and secure it using the cable tie.

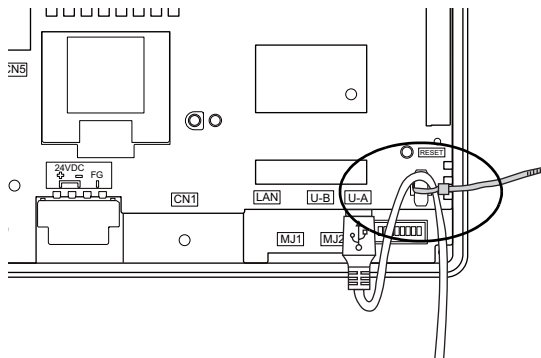

The following figure shows the case where only USB-B is used and the one where both USB-A and B are used.

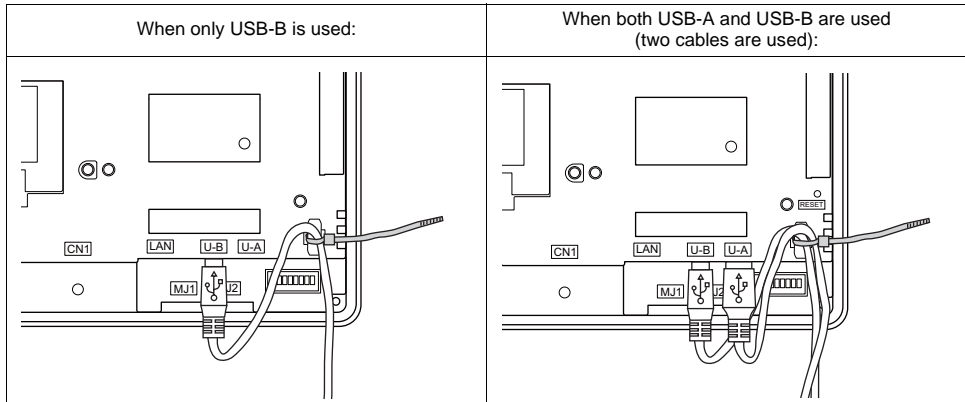

7. LAN Connector (LAN)

LAN Connector

An Ethernet-ready controller can be connected via a LAN connector.
The LAN connector supports 100BASE-TX/10BASE-T.

- For V812/V810

Bottom View

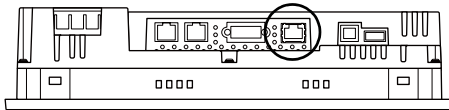

- For V808

Bottom View

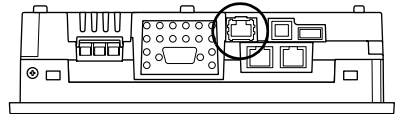

CAUTION

MJ1 (or MJ2) and LAN connector are 8-pin modular jacks.

Check the indication on the unit and insert a cable into the correct position.

Do not connect any over voltage peripheral device to the LAN connector.

The LAN connector pins correspond to signals as given below.

Specification: IEEE802.3 (u) compliant, supporting UDP and TCP/IP

LAN	Pin No.	Signal	Contents
	1	TX+	Ethernet send signal (+)
	2	TX-	Ethernet send signal (-)
	3	RX+	Ethernet receive signal (+)
	4	NC	Not used
	5	NC	Not used
	6	RX-	Ethernet receive signal (-)
	7	NC	Not used
	8	NC	Not used

Wiring



When using the LAN port, keep the LAN cable away from the power supply cable as much as possible.

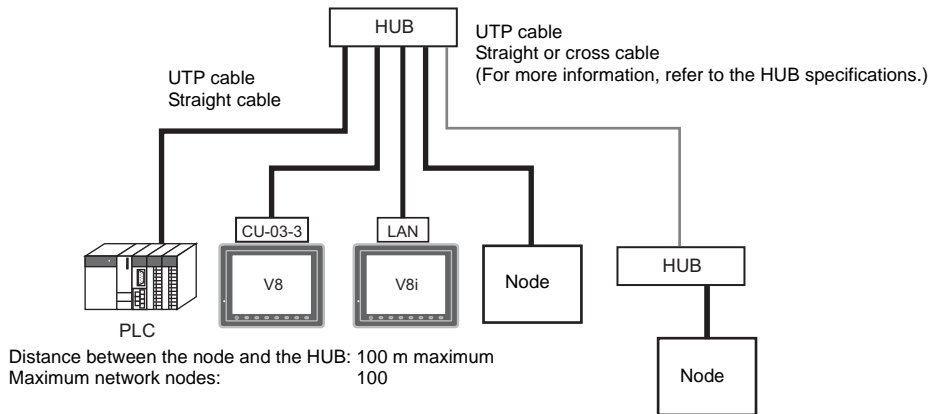

Cable Connection Diagram

Straight cable
(with hub)

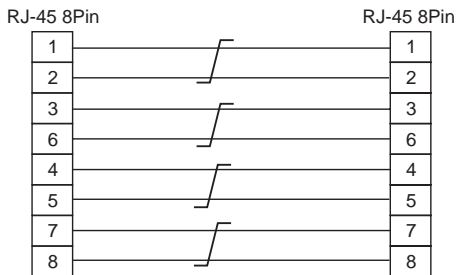

* Unshielded twist-pair cable

Cross cable
(without hub)

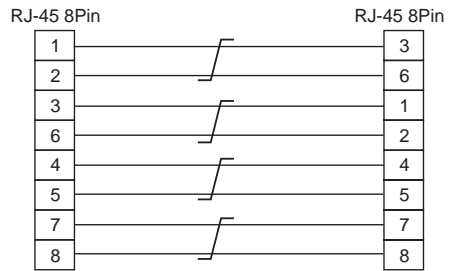

* Unshielded twist-pair cable

Recommended Cable

Use a commercially available cable. Using a self-made cable may cause an error in network connection.

Recommended cable: 100Ω, UTP (unshielded twist-pair) cable, category 5

8. CF Card

CF Card Connector

Screen data can be transferred and historical data and image data can be saved on the CF card. The CF card interface is provided at the rear of the unit.

- For V812/V810

Rear View

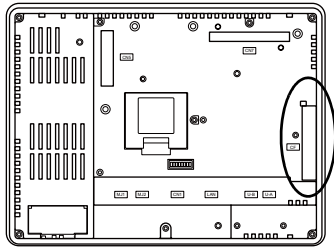

- For V808

Rear View

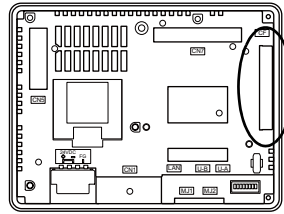

Enlarged View

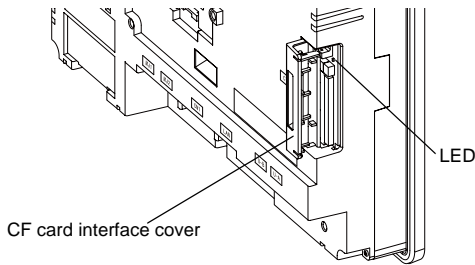

* Hardware version "a" to "l" of V812xS/V810xS/V810xT/V808xS

Enlarged View

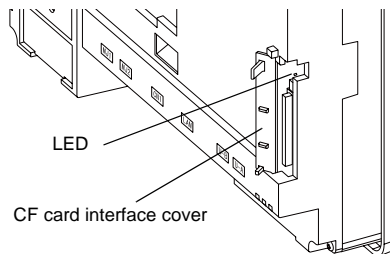

LED

With the DIPSW2, the LED status when the CF card interface cover is opened can be set.

DIPSW2	LED	Contents
OFF	Off	The power is not supplied to the CF card. The CF card can be removed.
	Lights up in red	The power is supplied to the CF card. At the completion of access, the LED goes off.
ON	Lights up in red	Access to the CF card is possible at all times.

CAUTION

When the DIPSW2 is set to the ON position, access to the CF card is possible whether the cover is opened or not. In case access to the CF card is disabled because of damage of the CF card interface cover, set the DIPSW2 to the ON position. Normally keep it in the OFF position.



Notes on Handling the CF Card

1. The V8 series can recognize a CF card in the file system of FAT or FAT32.
2. The LED lamp on the CF card interface cover illuminates in red when the power is supplied to the CF card. Do not insert or remove the CF card while the LED lamp is illuminating. Doing so may destroy data on the CF card. Check that the LED lamp has gone off before inserting or removing the CF card.
 - * DIPSW2: OFF (Refer to "LED" on page 2-34.)
3. Do not turn the main unit off during access to the CF card.
4. Make a backup copy of the CF card at regular intervals.
5. If a disk error occurs and data read/write operation is disabled, perform a scan disk on Windows and try to restore the disk. If not restored, format the CF card. Note that data on the CF card will be completely deleted by formatting. (For information on scan disk and Windows operations, refer to the manual for Windows.)
6. The number of writing times per CF card is limited (approx. 300,000 times). Consequently, frequent writing at short intervals may shorten service life of the CF card. When using a CF card to save sampling data, be aware of the sampling time. Also, avoid repeated writing using a CYCLE macro command.
7. When using the CF card of a large capacity (2G or above), it may take long time for the V8 recognize the CF card. Do not insert or remove the CF card in a short time.

CF Card Insertion/Removal Procedure

1. Open the CF card interface cover.
2. Insert the card securely into the interface with the card backside outwards viewed from the side of the unit as shown below.



CAUTION

Insert the CF card into the V8 unit in the correct orientation. Failure to do so may damage the CF card or the socket at the unit.

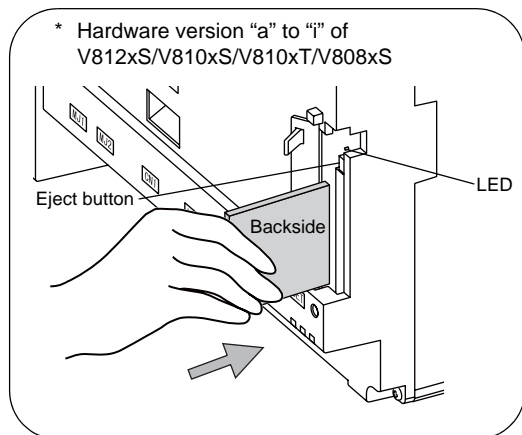
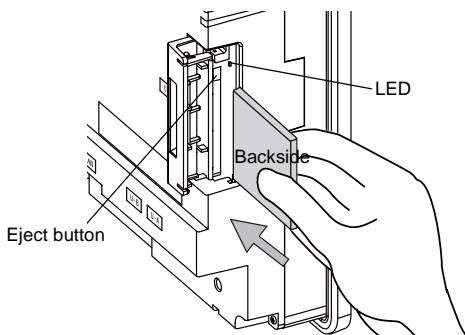

3. Close the CF card interface cover. The LED lamp lights up in red.
4. To remove the card, open the CF card interface cover first. When the LED lamp has gone off, press the eject button. The card pops out.

MEMO

Please use this page freely.

3 Installation

1. Mounting Procedure
2. Power Supply Cable Connection

1. Mounting Procedure

Mounting Procedure

1. Insert the V8 unit into the mounting panel (max. thick: 5 mm).

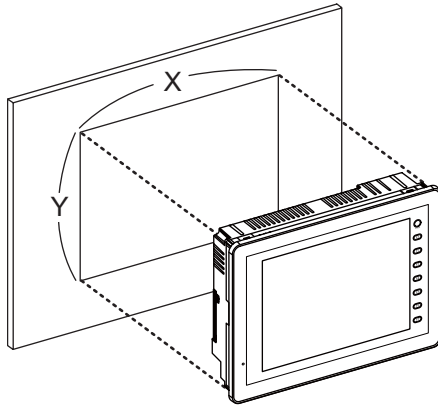

Panel cut-out dimensions

Model	X	Y
V812 / V812i	313.0 ^{+0.5} ₋₀	246.2 ^{+0.5} ₋₀
V810 / V810i	289.0 ^{+0.5} ₋₀	216.2 ^{+0.5} ₋₀
V808 / V808i	220.5 ^{+0.5} ₋₀	165.5 ^{+0.5} ₋₀

Unit: mm

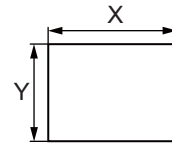

2. Insert four fixtures attached to the V8 series into the mounting holes, and tighten them with the tightening screws.
Tightening torque: 0.5 to 0.7 N•m

Fixture dimensions
(Unit: mm)

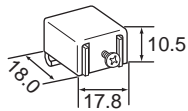

* When the V8 unit is attached to the mounting panel, the fixtures and frame grounds (FG) are connected. To prevent static electricity, be sure to connect the mounting panel to the frame ground.

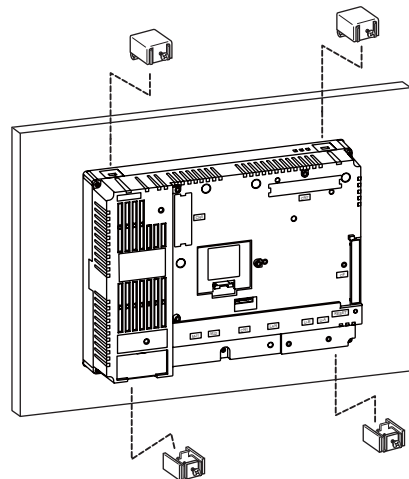

3. Mount the gasket so that it will be sandwiched securely between the V8 unit and the mounting panel.

Mounting Angle

Install the unit within the angle of 15° to 135° as shown on the right.

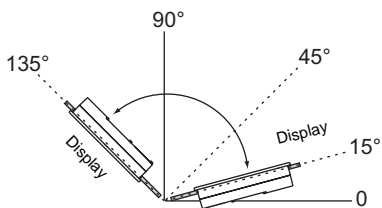

Type	Optional Unit	Communication Unit	Mounting Angle
V812xS V810xS V810xT V808xS	None	None	15° to 135°
		CU-xx	
	GU-xx	None	
		CU-xx	
V810xC V808xC	-	None	45° to 135°
		CU-02 CU-06 (Hardware version "d" and earlier)	
		CU-00 CU-01 CU-03-3 CU-04 CU-06 (Hardware version "e" and later) CU-07 (I/F driver under development) CU-08	15° to 135°

2. Power Supply Cable Connection



Electric shock hazard
Shut the power off before connecting the power supply cable.

Power Supply Cable Connection

Connect the power supply cable to the terminal on the backside of the unit.

- For V812/V810

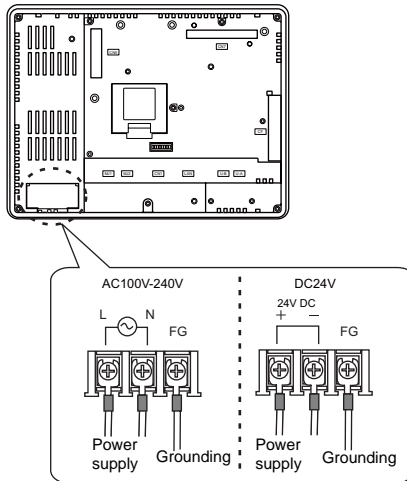

- For V808

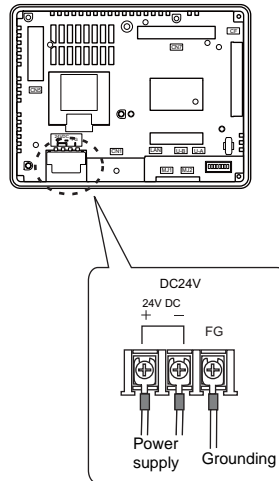

- Tighten terminal screws on the power supply terminal block with the following torque.
Use a power supply cable within the range shown below.

Model	Terminal Screw			Power Cable
	Screw Size	Tightening Torque	Crimp-style Terminal	
V812 V810	M3.5	0.8 N•m		AWG16 - 18
V808	M3.5	0.8 N•m		AWG14 - 16

Notes on the Power Supply:

- The power source must be within the allowable voltage fluctuation.
- Use a power source with low noise between the cables or between the ground and the cable.
- Use as thick a power supply cable as possible to minimize drop in voltage.
- Keep power supply cables away from high-voltage, large-current carrying cables.

Notes on Usage of 100 - 240 VAC Specifications

- Generally, an isolating transformer improves noise resistance. However, if the display unit is far away from the secondary port of the transformer and noise gets mixed in, an isolating transformer becomes unnecessary.
- If any power voltage fluctuation caused by noise is expected, it is recommended that a voltage stabilizer (effective in noise resistance) be used.

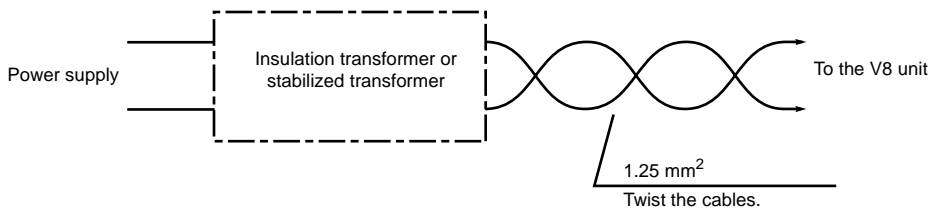

Grounding



CAUTION

Be sure to establish a ground of the V8 series.
(The level of grounding resistance should be less than 100Ω.)

- An independent earth pole must be used for MONITOUCH.
- Use a cable which has a nominal cross section of more than 2 mm² for grounding.
- Set the grounding point near MONITOUCH to shorten the distance of grounding cables.

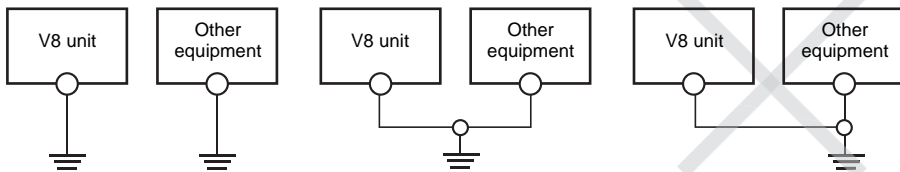

- * When the V8 unit is attached to the mounting panel, the fixtures and frame grounds (FG) are connected. To detach the FG terminal from the ground, attach the insulating sheet to the fixtures and the mounting panel for insulation.

4 Instructions

1. Coin-type Lithium Battery (V7-BT)
2. DIP Switches
3. Function Switches

1. Coin-type Lithium Battery (V7-BT)

CAUTION

MONITOUCH is delivered without inserting the battery connector in the battery holder on the back of the unit.
Be sure to set the battery when using the calendar function or SRAM.
Without a battery, the contents in the SRAM or calendar will not be retained.

Battery Usage

The battery is used for the user memory area (non-volatile memory \$L and \$LD, storing sampling data, etc.) in SRAM, or backup battery for the built-in clock.

Battery Mounting Procedure

DANGER

Electric shock hazard
Steps 2 to 5 must be performed when the power to the V8 series is turned off.

1. Turn the unit off.
2. Open the battery holder cover in the direction of the arrow as shown in the left illustration below.

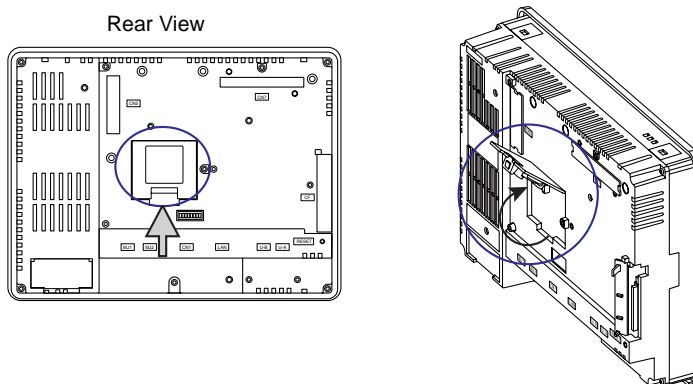

3. Check that the battery is securely attached to the backside of the cover, and connect the battery connector.

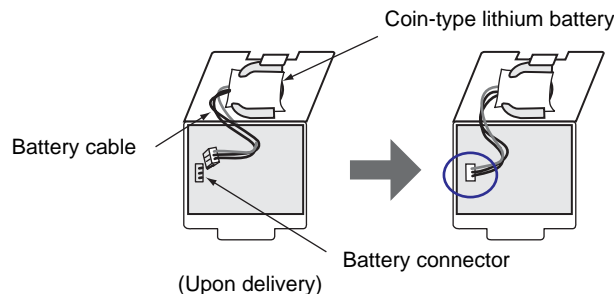

4. Close the battery holder cover.
5. Enter a date five years from now for "Battery replacement" on the sticker on the battery holder.

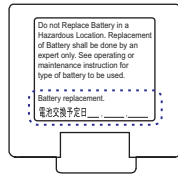

Write down the date five years from now.

6. Turn the V8 unit off.
When no battery is set, the message "Battery not set" is displayed, and when the battery voltage has dropped, the message "Brownout Battery" is displayed at the bottom center of the Main Menu screen.

Main Menu screen when the battery is not connected

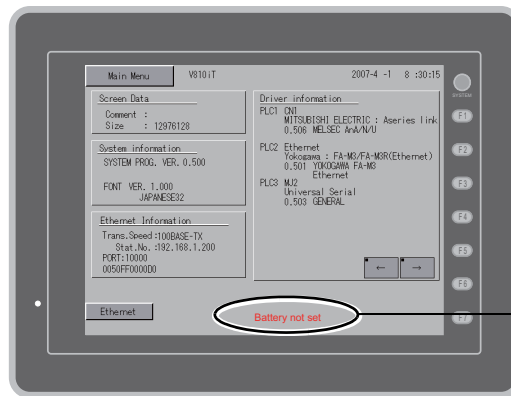

The message "Battery not set"

Battery Voltage Drop Detection

The battery status is output to the internal memory \$s167 of the V8 series. When the battery voltage is lowered, the message "Brownout Battery" is displayed at the bottom center on the Main Menu screen.

If the battery voltage drops (4th bit is set) before five years has elapsed, replace the battery immediately.

	15	14	13	12	11	10	09	08	07	06	05	04	03	02	01	00
MSB	15	14	13	12	11	10	09	08	07	06	05	04	03	02	01	00
\$s167	0	0	0	0	0	0	0	0	0	0	0	0	0	0	0	0

System reserved (Setting: 0)

0: Battery OK.
1: Battery voltage drop
2: No battery

Battery Replacement

Replacement batteries are available from Hakko Electronics.

Name	Model	Contents
Battery for replacement	V7-BT	<ul style="list-style-type: none"> Coin-type lithium primary cell 1 pce. Cautions sticker 1 pce.

Safety Instructions on Handling the Battery

Lithium batteries contain combustible material such as lithium or organic solvent. Mishandling may cause heat, explosion or ignition resulting in fire or injury. To prevent accidents, pay attention to the following cautions when handling the lithium battery.



CAUTION

- Be sure to discharge static electricity from your body before battery replacement.
- Use the battery "V7-BT" (replacement battery) for replacement.
- Rough handling of the battery may cause a fire or chemical burn hazard.
- Do not disassemble, incinerate or heat the battery.
- Observe local and governmental regulations when disposing of waste batteries.
- Keep batteries out of reach of children. (If swallowed, immediately consult a doctor.)
- Never re-charge the battery.
- When the battery leaks or smells, the leaking battery electrolyte may catch fire. Keep from heat or flame.

SRAM Area Backup Procedure

Replace the battery "V7-BT" within three minutes after the unit is turned off.

If it is not possible to replace within three minutes, use the V-SFT-5 editor or a CF card and make a backup copy of data in the SRAM.

When Using the V-SFT-5 Editor:

- 1) Connecting a cable
Connect the V8 unit and the computer using the transfer cable ("V-CP", USB cable, Ethernet cable)
 - 2) Starting the V-SFT-5 editor
Start the V-SFT-5 editor on the computer.
 - 3) Displaying the [Transfer] dialog
Click the [Transfer] icon. The [Transfer] dialog is displayed.
 - 4) Selecting data to be transferred
Select [Display] for [Transfer Device], and [SRAM Data] for [Transfer Data].
Do not check [Use Simulator].
 - 5) Starting SRAM data transfer
Click the [PC <-] button under [Transfer]. Data transfer from the SRAM is started.
 - 6) Saving the SRAM data
When the SRAM data has been transferred, the [Save As] dialog is displayed on the computer. Save the data as a backup copy. The extension is "*.RAM".
- * To transfer the "*.RAM" data saved as a backup to the V8, click the [PC ->] button under [Transfer] in step 5).

When Using a CF Card:

For the backup procedure with a CF card, refer to "Saving Backup Copies of SRAM" (page 5-24).

Battery Replacement Procedure

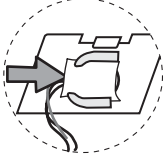
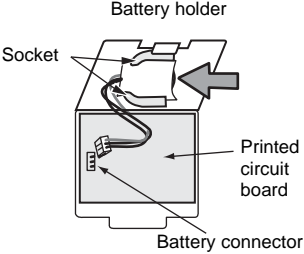
1. Turning the power of the V8 unit off
Turn the power of the V8 unit off, and open the battery holder. The battery in the socket will come into view.
2. Battery removal
Unplug the battery connector. Slide the battery toward the direction shown in the figure on the right, and remove the battery from the socket.
 
3. New battery installation
Fit the battery into the socket in such a manner that the red cable side of the new battery faces the board and the cable is on the left of the battery. Before fitting the battery into the socket, slide it toward the direction shown in the figure on the right.
 
4. Battery connector plug-in
Plug in the battery connector and close the battery holder cover.
5. Entering an expiry date of the battery
Remove the existing caution sticker. Enter a date five years from now for "Battery replacement" as an expiry date on the new caution sticker, and attach it to the battery holder.
6. Turning the power of the V8 unit on
Turn the power of the V8 unit on and check that the battery is correctly set on the Main Menu screen.
7. Backup data transfer
If the backup data "*.RAM" has been made, transfer it to the V8 series.

2. DIP Switches

DIP Switch (DIPSW) Setting

The V8 series is equipped with eight (1 to 8) DIP switches. When setting the DIP switch, turn the power off.
 Upon delivery, all the DIP switches are set to OFF.

For V812xS / V810xS / V810xT / V810xC
 Rear View

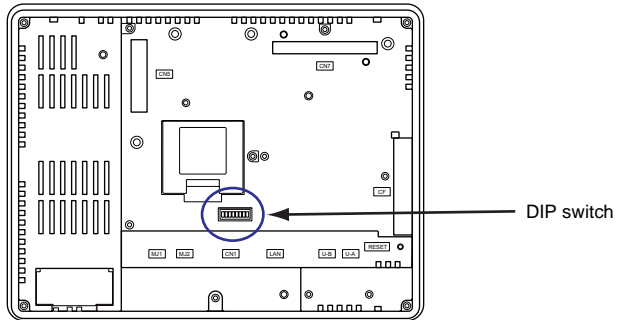

For V808xS
 Rear View

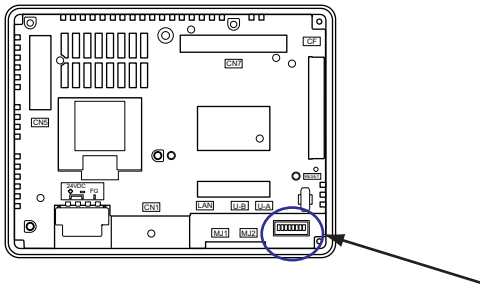

For V808xC
 Rear View

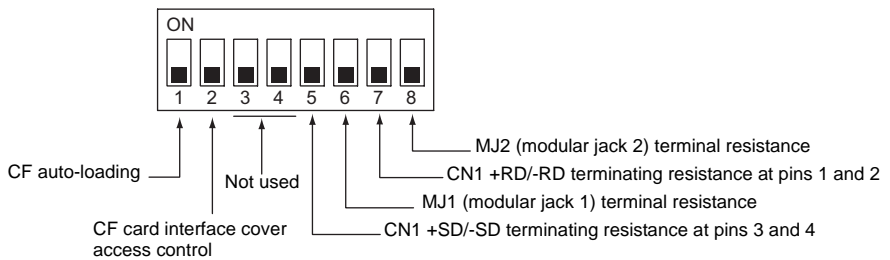
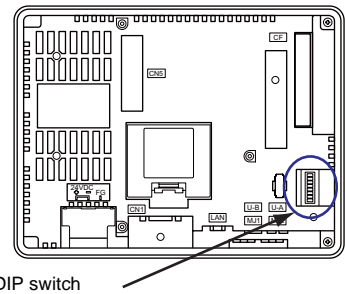

DIPSW1* (CF Auto Loading)

Set the DIPSW1 to the ON position when auto-loading a screen data file saved on a CF card.

Procedure

1. Have a CF card.
Have a CF card to which the screen data is loaded using the V-SFT-5 editor. (For the loading procedure, refer to the V8 Series Reference Manual.)
2. Insert a CF card.
Turn the power of the V8 unit off, and set the DIPSW1 to the ON position. Open the CF card interface cover, and insert a CF card.
3. Auto-loading starts.
Turn the power of V8 unit on. The screen data is automatically loaded into the FLASH memory of MONITOUCH.

* Be sure to set the DIPSW1 to the OFF position if you do not use CF auto-loading function.

DIPSW2 (CF Card Interface Cover Access Control)



CAUTION

When the DIPSW2 is set to the ON position, access to the CF card is possible whether the cover is opened or not. In case access to the CF card is disabled because of damage of the CF card interface cover, set the DIPSW2 to the ON position. Normally keep it in the OFF position.

With the DIPSW2, the LED status when the CF card interface cover is opened can be set.

DIPSW2	LED	Contents
OFF	Not lit	Access to the CF card is not performed. CF card can be removed.
	Lights up in red	Accessing the CF card After the access is finished, the LED goes off.
ON	Lights up in red	Access to the CF card is possible at all times.

DIPSW3, 4 (Not Used)

Set the DIPSW3 and 4 to OFF.

DIPSW5, 6, 7, 8 (Terminating Resistance Setting)



CAUTION

When connecting a controller at CN1 via RS-232C, set the DIPSW5 and 7 to the OFF position.

- When connecting a controller at CN1 via RS-422/485 (2-wire connection), set the DIPSW7 to the ON position.
- When connecting a controller at CN1 via RS-422/485 (4-wire connection), set the DIPSW5 and 7 to the ON position.
- For the following connections at modular jack 1 or 2, set the DIPSW6 or 8 to the ON position.
 - Master station for multi-link 2 connection
 - Connection with a controller (PLC, temperature controller, etc.) via RS-485
 - Connection with the card recorder "CREC" (optional)
 - Connection with the serial extension I/O "V-I/O" (optional)
 - Connection to the V8 series at the termination of V-link connection via RS-485

3. Function Switches

Types

There are eight function switches provided.
[SYSTEM], [F1], [F2], [F3], [F4], [F5], [F6], [F7]

Function of Switches

[SYSTEM] Switch

The [SYSTEM] switch works in “alternate” operations.
When the [SYSTEM] switch is pressed once, the switch menu is displayed at the left side of the function switches [F1] to [F7] as shown in the figure below. Each function switch corresponds to the item displayed in the switch menu.

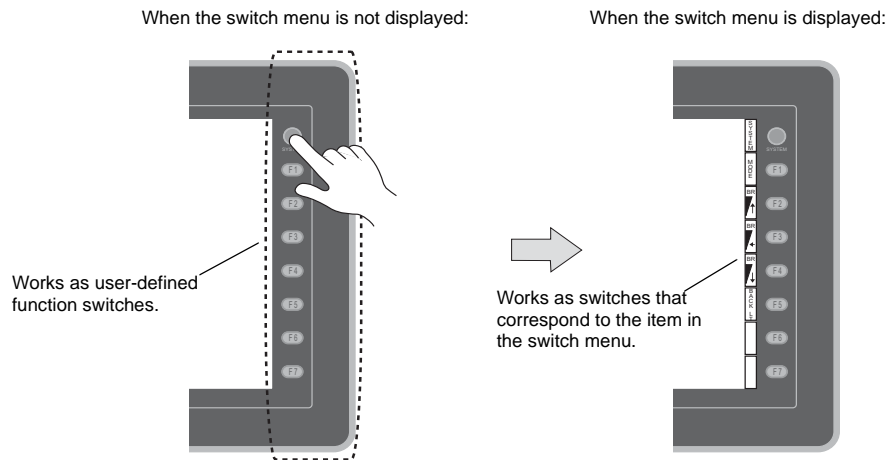

* If the switch menu is not displayed with the [SYSTEM] switch pressed, the [SYSTEM] switch is disabled. To enable the [SYSTEM] switch, keep pressing the [F7] switch for the time specified for [Change-over Time] (max. 30 seconds) with the [SYSTEM] switch held down. [Change-over Time] is set on the editor.

[F1] to [F5] Switch Functions with Switch Menu Displayed

	Functions	Specifications	
F1	Mode selection	Selects the operation mode between STOP ↔ RUN.*2	
F2	Brightness	Bright	
F3*1		Medium	
F4*1		Dark	
F5	Backlight control*3	Always ON	-
		Auto 1 Auto 2 Auto 3	<ul style="list-style-type: none"> The [F5] switch turns the backlight off. This is valid when the backlight control bit (bit 11) in the read area "n + 1" in the system memory is reset (OFF: 0).
		Manual Manual 2	<ul style="list-style-type: none"> Manual The [F5] switch turns the backlight off. To turn it on, press somewhere on the screen or a function switch. Manual 2 The [F5] switch turns the backlight on and off. [Backlight Power ON Time Control] that determines the backlight status at power-up becomes valid. When the power is turned on: ON → Backlight ON OFF → Backlight OFF
F6		-	
F7		-	

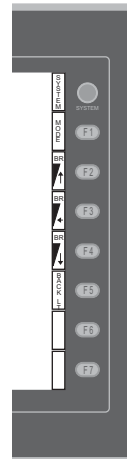

*1 When a medium or dark brightness is set, the backlight service life may become shorter.

*2 If the mode cannot be changed between STOP and RUN using the [MODE] switch, the [F1] (MODE) switch is disabled. To enable the [F1] (MODE) switch, keep pressing the [F7] switch for the time specified for [Change-over Time] (max. 30 seconds) with the [F1] switch held down while the switch menu is displayed by pressing the [SYSTEM] switch. [Change-over Time] is set on the editor.

*3 The backlight can be controlled by the setting in the [Backlight] tab window that is displayed by selecting [System Setting] → [Unit Setting] → [Backlight] on the V-SFT-5 editor.

User-defined Settings for Function Switches [F1] to [F5]

When the V8 series is in the RUN mode and the switch menu by the [SYSTEM] switch is not displayed, the function switches can be defined by the user.

User-defined function switches should be set on the V-SFT-5 editor.

- Settings for each screen
[Screen Setting] → [Local Function Switch Setting] → [Local Function Switch Setting] dialog
- Setting for all screens
[System Setting] → [Global Function Switch Setting] → [Global Function Switch Setting] dialog

* If the switch menu is not displayed by the [SYSTEM] switch on the Main Menu screen, no function is specified for each function switch.

5 **MONITOUCH** **Operations**

1. Before Operation
2. Main Menu Screen

1. Before Operation

Procedure before Operation

1. Mount the V8 series on the mounting panel, install it and carry out wiring.
For more information, refer to “Chapter 3”.
2. Install peripheral devices, such as PLCs or temperature controllers, and carry out wiring.
For information on precautions, refer to the V8 Series Connection Manual separately provided.
3. Turn the power of the V8 series on.

When turning the power on for the first time:



Other cases:



4. Transfer the created screen data.
 - When turning the power on for the first time:
For details, refer to “Transferring Screen Data to MONITOUCH for the First Time” (page 5-2).
 - Other cases:
For the procedure to change screen data with another, refer to the V8 Series Operation Manual.
5. Start MONITOUCH operation. To change to the RUN mode, refer to “Main Menu Screen” (page 5-3).

When the connection with controllers has been established, the RUN screen is displayed.

- * If MONITOUCH does not operate normally and shows an error message, eliminate the cause by referring to “Chapter 6” or the V8 Series Reference Manual.

Transferring Screen Data to MONITOUCH for the First Time

There are five methods for transferring screen data for the first time.

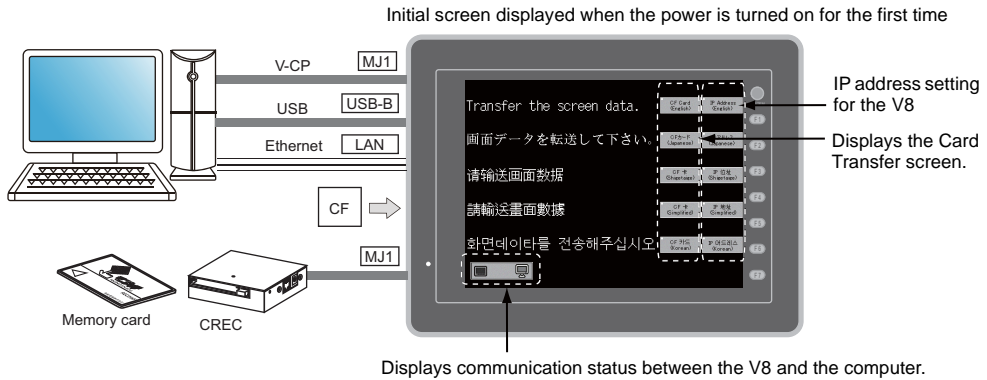

- 1) Serial transfer
Connect the screen data transfer cable “V-CP” to the modular jack 1 on the V8 series, and transfer screen data from the computer.
- 2) Transfer via USB
Connect the USB cable to the USB slave port (USB-B) on the V8 series, and transfer screen data from the computer.
- 3) Transfer using a card
A CF card or card recorder “CREC” (optional) and memory card are required.
Load screen data from the computer to the card in advance. Press the [CF Card (English)] switch on the initial screen. The Card Transfer screen is displayed and data transfer is enabled.
- 4) Transfer using a CF card (auto-loading)
Load screen data from the computer to the card in advance. When the power of MONITOUCH is turned on, screen data transfer is automatically started.
- 5) Transfer via Ethernet
Connect an Ethernet cable to the LAN port on the V8 series, and transfer screen data from the computer.
Pressing the [IP Address (English)] switch on the initial screen brings up the Ethernet screen on which you can set the IP address for the V8 series.

When the screen data has been transferred, the following screen is brought up. For details, refer to “Main Menu Screen” (page 5-3).

Main Menu screen after screen data is transferred

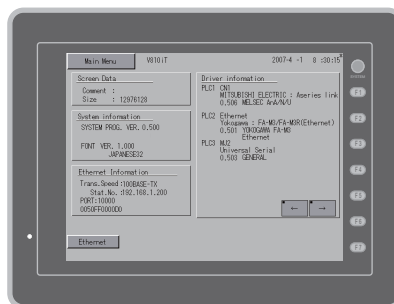

2. Main Menu Screen

Displaying the Main Menu Screen

To bring up the Main Menu screen in the RUN mode, press the [SYSTEM] switch and then the [F1] switch (*2) while the switch menu is displayed (*1).

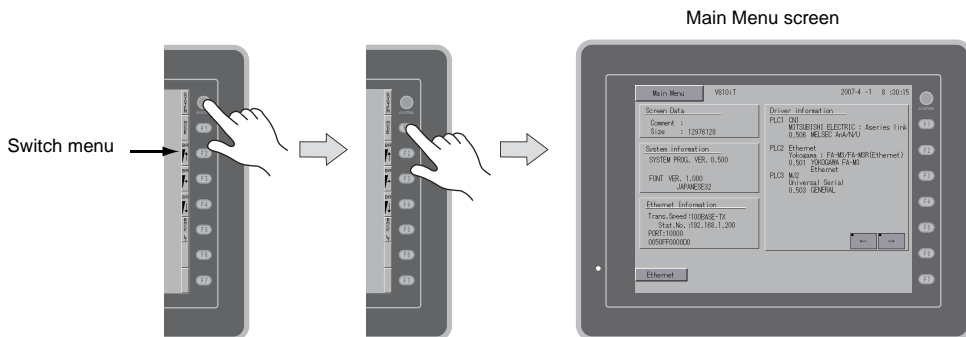

- *1 If the switch menu is not displayed with the [SYSTEM] switch pressed, the [SYSTEM] switch is disabled. To enable the [SYSTEM] switch, keep pressing the [F7] switch for the time specified for [Change-over Time] (max. 30 seconds) with the [SYSTEM] switch held down. [Change-over Time] is set on the editor.
- *2 If the Main Menu screen is not brought up with the [F1] switch pressed, the [F1] (= [MODE]) switch is disabled. To enable the [F1] (= [MODE]) switch, keep pressing the [F7] switch for the time specified for [Change-over Time] (max. 30 seconds) with the [F1] switch held down while the switch menu is displayed by pressing the [SYSTEM] switch. [Change-over Time] is set on the editor.

Main Menu Screen

The Main Menu screen indicates the V8 series model, system information, and screen data information.

Also, it works as the system screen when the screen data is transferred between a computer and the V8 series. To transfer screen data from the computer to the V8 series through serial communication, display this Main Menu screen. (However, if [No connection] is selected for [Modular Jack1], it is not necessary to bring up this screen.)

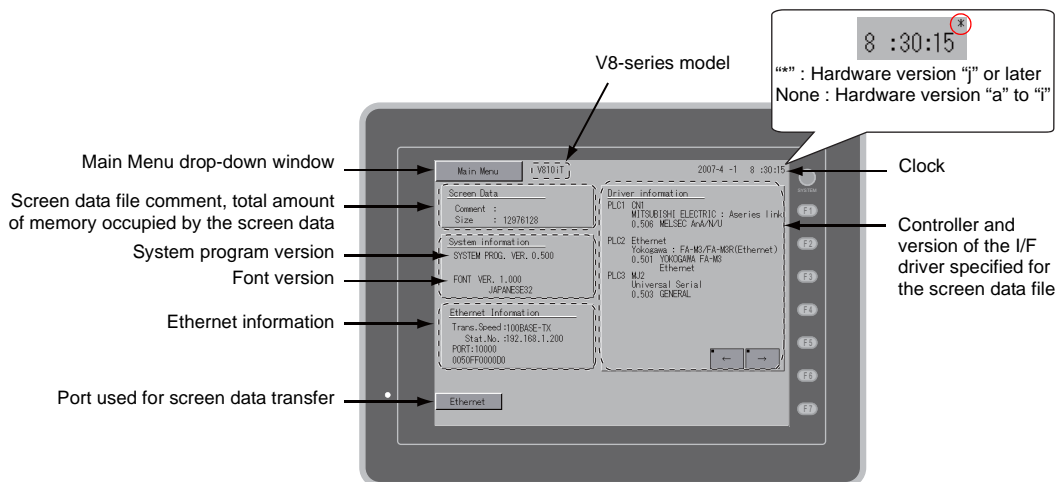

* For more information on the hardware version, refer to page 7-3.

[Main Menu] Switch

Pressing the [Main Menu] switch brings up the following drop-down window.

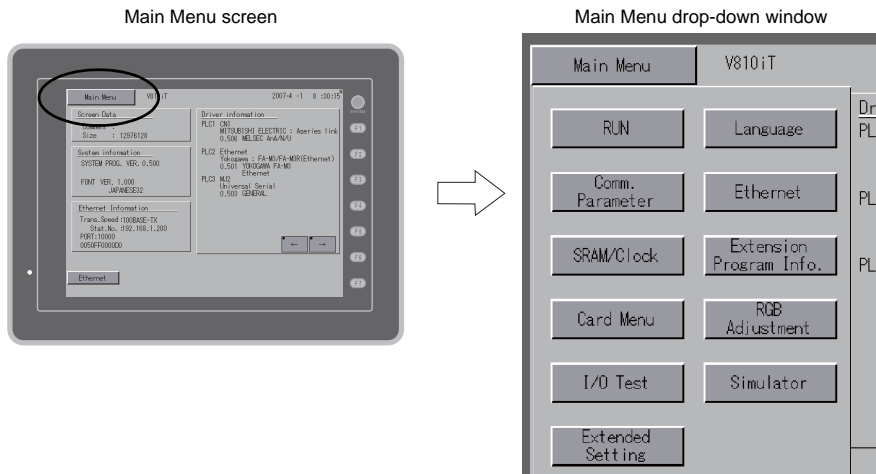

Main Menu Screen Composition

The Main Menu screen is configured as shown below:

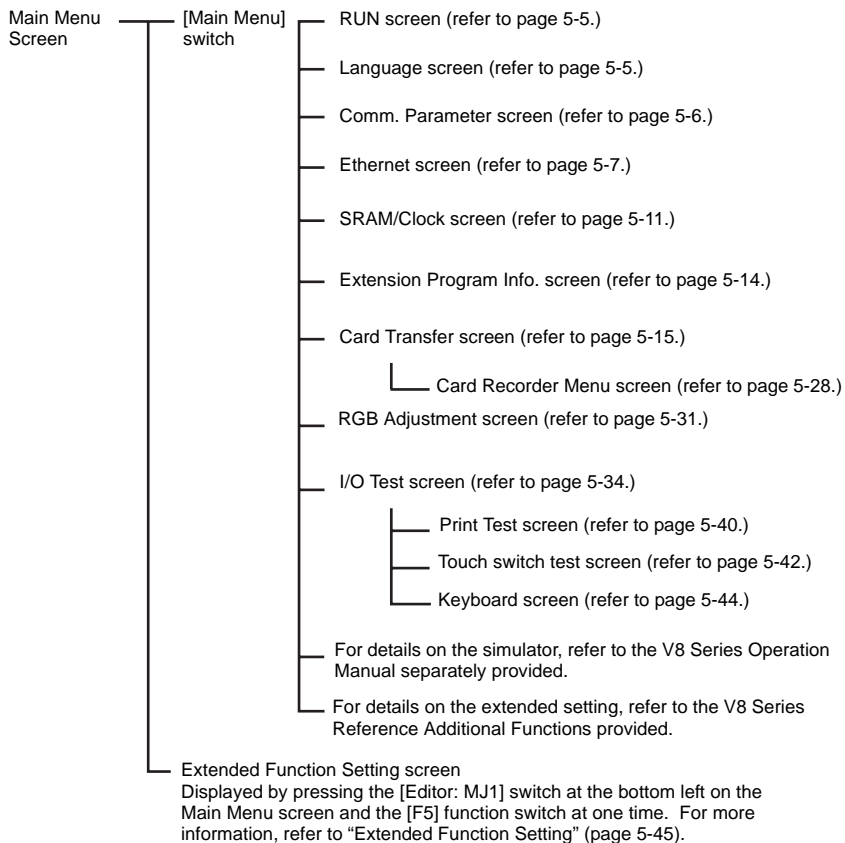

1. RUN

Pressing the [RUN] switch on the Main Menu drop-down window switches the screen to the RUN mode.

Main Menu drop-down window

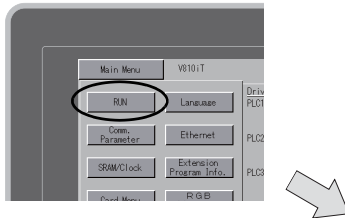

RUN screen



2. Language Selection

Pressing the [Language] switch on the Main Menu drop-down window brings up the Language Selection screen.

Languages (*) selected in the [Font Setting] dialog of the V-SFT-5 editor are displayed on the Language Selection screen that is used for selecting an interface language for the Main Menu screen.

Main Menu drop-down window

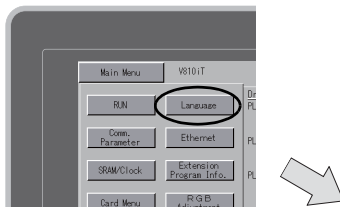

Language Selection screen

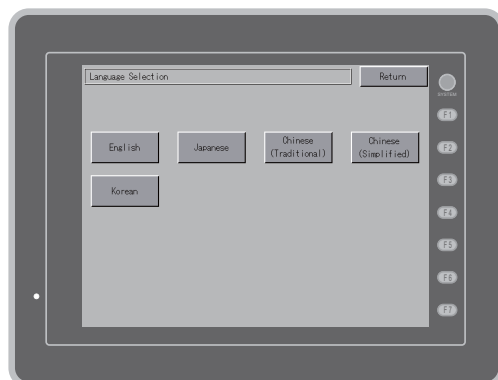

* The interface language for the Main Menu screen can be selected from English, Japanese, Chinese (simplified), Chinese (traditional) or Korean. English is always displayed.

3. Communication Parameter

Pressing the [Comm. Parameter] switch on the Main Menu drop-down window brings up the Comm. Param. screen.

Communication parameters of PLC1 to PLC8 that are set on the V-SFT-5 editor can be checked on this screen.

Main Menu drop-down window

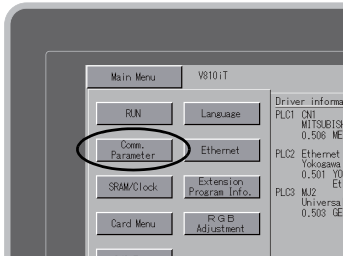

Comm. Param. screen

Displays a specified communication parameter.

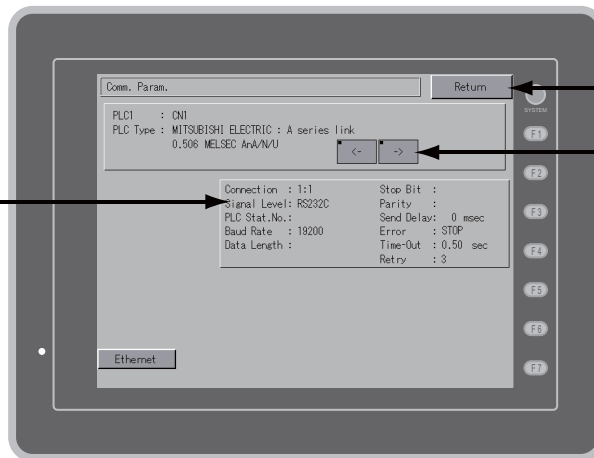

Moves back to the Main Menu screen.

Changes the display of the setting from PLC1 to PLC8.

4. Ethernet

Pressing the [Ethernet] switch on the Main Menu drop-down window brings up the Ethernet screen. This screen is used for setting an IP address for the V8 unit.

Main Menu drop-down window

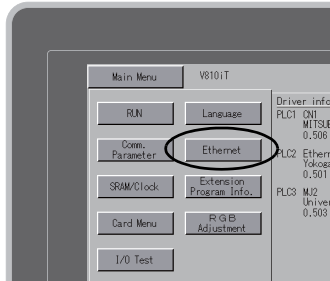

Ethernet screen

The Ethernet screen displays the following information and controls:

- Top Bar:** 'Ethernet' title and 'Return' button.
- Selection:** 'Built-in LAN' button (selected) and 'Extended LAN' button.
- IP Address Setting:** A box containing the text 'It is not used when the gateway or the sub-mask is zero.' and the following settings:

IP Address :	192 . 168 . 1 . 200
Gate Way :	0 . 0 . 0 . 0
Sub-mask :	255 . 255 . 255 . 0
Port No. :	10000

 Below this box is an 'EDIT' button.
- Bottom Bar:** 'Connect' button and 'Setting Finished' button.
- Right Side:** A vertical keypad with function keys F1 through F7.

Annotations and their meanings:

- Selects [Built-in LAN] or [Extended LAN].*1**: Points to the LAN selection buttons.
- Selects [IP Address Setting] or [Select IP Address from Network Table].*2**: Points to the IP Address Setting box.
- Moves back to the Main Menu screen or the initial screen.**: Points to the Return button.
- Displays the keypad for IP address setting.**: Points to the F1-F7 keypad.
- Indicates whether the LAN port works correctly with an Ethernet cable inserted.**
 - Normal: Connect (white)
 - Abnormal: Disconnect (gray)
- When making the setting, press the [Setting Finished] switch to determine the setting. The Main Menu screen is displayed.**: Points to the Setting Finished button.

*1 This is valid only when the Ethernet unit CU-03-3 is installed.

*2 Refer to the V8 Series Connection Manual.

4-1. IP Address Setting of the V8 Series

When using Ethernet communications, you need to set the IP address of the V8 unit. Set the IP address either on the V8 unit or for screen data using the V-SFT editor.

Setting on the V8 Unit

1. Press the [Ethernet] switch on the Main Menu drop-down window to display the Ethernet screen.
2. Select [Built-in LAN] or [Extended LAN] by pressing the switch to specify the port for setting.
3. Press the [EDIT] switch and set each item.

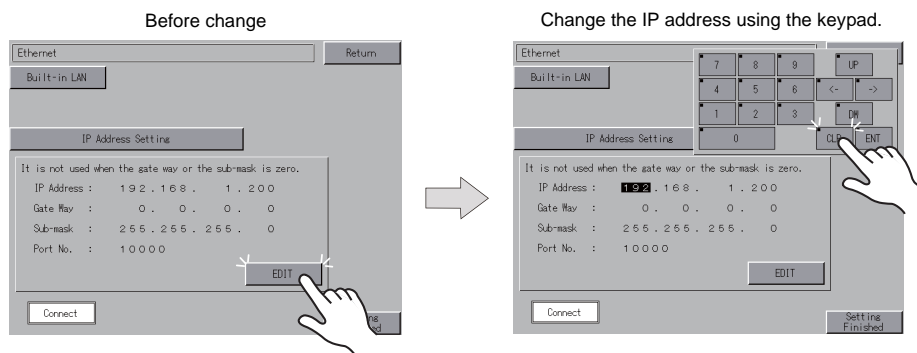

It is not used when the gateway or the subnet mask is zero.

4. Press the [Setting Finished] switch to determine the IP address. Check the IP address displayed at "Ethernet Information" on the Main Menu screen.

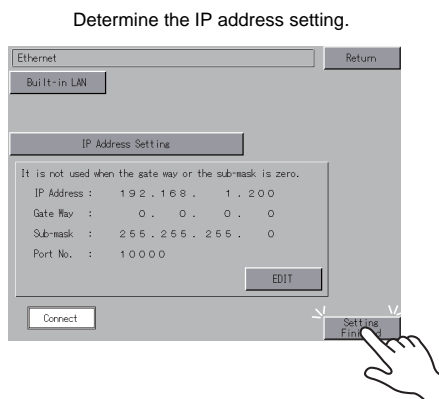

Setting using the V-SFT editor

1. Select [System Setting] → [Ethernet Communication] → [Local Port IP Address] on the V-SFT editor. The [IP Address Setting] dialog is displayed.
2. Specify the IP address.
When specifying an IP address for the built-in LAN port, select [IP Address Setting]. Alternatively, when specifying an IP address for the Ethernet unit, select [IP Address Setting (extended)].

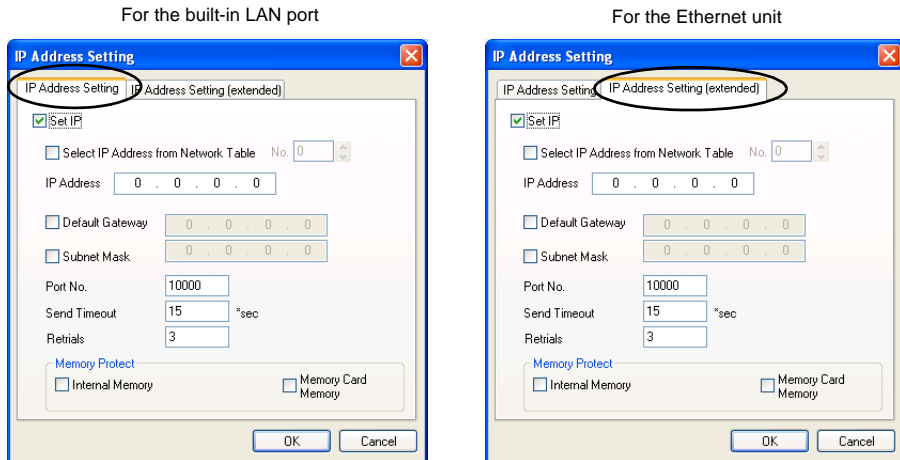

3. Check the Set IP] check box and set each item.

<input type="checkbox"/> Select IP Address from Network Table	This is valid when the IP address of the V8 has been registered in the network table. Select a network table number from 0 to 99 to set the IP address.
IP Address *	Set the IP address for the V8.
<input type="checkbox"/> Default Gateway *	Set the default gateway.
<input type="checkbox"/> Subnet Mask *	Set the subnet mask. When this box is not checked, the subnet mask is automatically assigned based on the bits at the extreme left of the IP address. Example: When IP address is "172.16.200.185", "255.255.0.0" is set. When IP address is "192.168.1.185", "255.255.255.0" is set.
<input type="checkbox"/> Port No. *	Set a port number from 1024 to 65535 other than 8001.
Send Timeout	Specify the timeout time to send the EREAD/EWRITE command.
Retrials	0 to 255 Set the number of retrials to be performed when a time-out occurs.
Memory Protect	
<input type="checkbox"/> Internal Memory	Check either check box to write-protect the memory from computers or other stations.
<input type="checkbox"/> Memory Card Memory	

* For more information on setting items, refer to page 5-10.

4. Click [OK].
5. Transfer the screen data to the V8 unit. Check the IP address displayed at "Ethernet Information" on the Main Menu screen.

IP Address				
This is an address that is used for recognizing each node on the Ethernet and should be unique. The IP address is 32-bit data which consists of the network address and the host address and can be classified into A to C depending on the network size.				
Class A	<table border="1"> <tr> <td>0</td> <td>Network address (7)</td> <td>Host address (24)</td> </tr> </table>	0	Network address (7)	Host address (24)
0	Network address (7)	Host address (24)		
Class B	<table border="1"> <tr> <td>10</td> <td>Network address (14)</td> <td>Host address (16)</td> </tr> </table>	10	Network address (14)	Host address (16)
10	Network address (14)	Host address (16)		
Class C	<table border="1"> <tr> <td>110</td> <td>Network address (14)</td> <td>Host address (8)</td> </tr> </table>	110	Network address (14)	Host address (8)
110	Network address (14)	Host address (8)		
<p><Notation> A string of 32-bit data is divided into four, and each segment delimited with a period is in decimal notation. Example: The IP address in class C shown below is represented as "192.128.1.50". 11000000 10000000 00000001 00110010</p> <p><Unusable IP addresses></p> <ul style="list-style-type: none"> • "0" is specified for one byte at the extreme left. Example: 0.x.x.x • "127" is specified for one byte at the extreme left (loop back address). Example: 127.x.x.x • "224" or more is specified for one byte at the extreme left (for multi-cast or experiment). Example: 224.x.x.x • The host address consists of only "0" or "255" (broadcast address). Example: 128.0.255.255, 192.168.1.0 				

Port No.
Multiple applications are running on each node, and communications are carried out for each application between the nodes. Consequently, it is necessary to have a means to identify the application that data should be transferred to. The port number works as this identifier. Each port number is 16-bit data (from 0 to 65535). The V8 series uses the port for screen data transfer (8001), PLC communication (as desired), and the simulator (8020). Set a unique number in the range of 1024 to 65535. For a PLC or a computer, set the port number in the range of 256 to 65535. It is recommended to set a greater number.

Default Gateway
A gateway and a router are used for communication between different networks. The IP address of the gateway (router) should be set to communicate with the node(s) on other network.

Subnet Mask													
A subnet mask is used for dividing one network address into multiple networks (subnet). The subnet is assigned by specifying a part of the host address in the IP address as a subnet address.													
Class B	<table border="1"> <tr> <td>10</td> <td>Network address (14)</td> <td>Host address (16)</td> </tr> </table>	10	Network address (14)	Host address (16)									
10	Network address (14)	Host address (16)											
Subnet mask	<table border="1"> <tr> <td>255.</td> <td>255.</td> <td>255.</td> <td>0</td> </tr> <tr> <td>11111111</td> <td>11111111</td> <td>11111111</td> <td>00000000</td> </tr> <tr> <td>Network address</td> <td>Subnet address</td> <td>Host address</td> <td></td> </tr> </table>	255.	255.	255.	0	11111111	11111111	11111111	00000000	Network address	Subnet address	Host address	
255.	255.	255.	0										
11111111	11111111	11111111	00000000										
Network address	Subnet address	Host address											
<p><Unusable subnet masks></p> <ul style="list-style-type: none"> • All bits are set to "0". (0.0.0.0) • All bits are set to "1". (255.255.255.255) 													

5. SRAM/Clock

Pressing the [SRAM/Clock] switch on the Main Menu drop-down window brings up the SRAM/Clock screen.

This screen is used for correcting the built-in calendar (date and time), for formatting the SRAM area, and for clearing learning/user phrase area in the Japanese FEP function.

Main Menu drop-down window

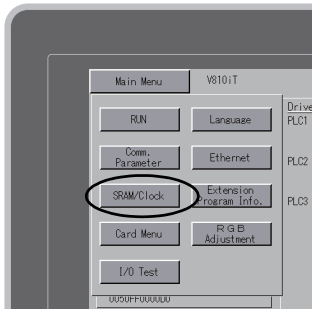

SRAM/Clock screen

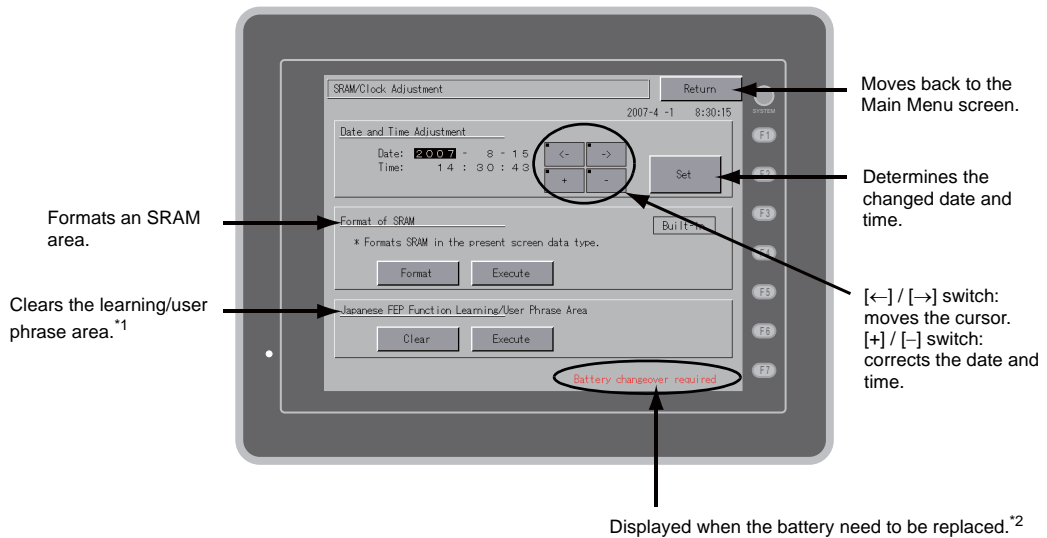

*1 This option is displayed when [Use Japanese Conversion Function] in the [System Setting] menu is checked on the V-SFT-5 editor. For the setting procedure, refer to the V8 Series Reference Manual.

*2 Be sure to set the battery. Without the battery, the contents in the SRAM or clock data will not be retained.

5-1. Date and Time Adjustment

This screen is used for correcting the built-in clock of the V8 series.

To use the built-in clock of the V8 series, check [Use Built-in Clock] in the [SRAM/Clock Setting] dialog that is displayed by selecting [System Setting] → [Unit Setting] → [SRAM/Clock] on the V-SFT-5 editor.

1. Move the cursor using the [←] and [→] switches. Correct the date and time using the [+] and [−] switches.
2. Press the [Set] switch to determine the setting. The clock displayed at the top right is modified.

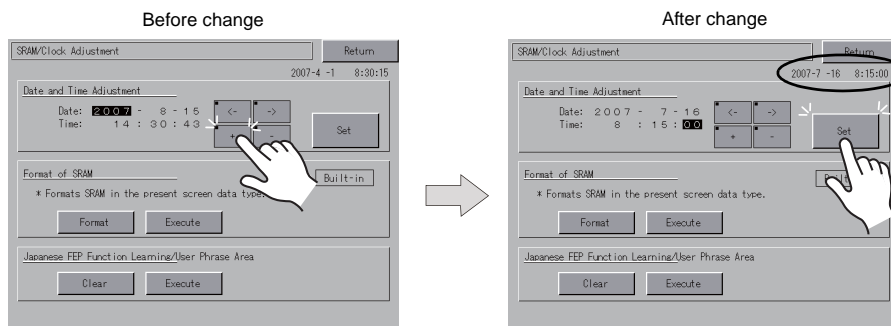

3. Pressing the [Return] switch displays the Main Menu screen again.

5-2. Formatting SRAM

An SRAM area can be formatted.

When the SRAM area is formatted, the contained data (historical data saved in SRAM, internal memory \$L, etc.) is cleared. Double-check before formatting the SRAM.

1. Press the [Format] switch and the [Execute] switch.
The SRAM area is formatted in the current screen data format. When formatting has been completed, the message ****Format Completed**** is displayed.

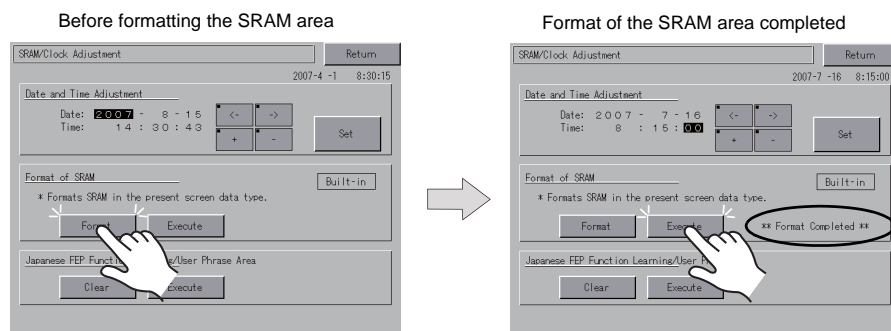

2. Pressing the [Return] switch displays the Main Menu screen again.

5-3. Japanese FEP Function Learning/User Phrase Area

The area used by the Japanese FEP function can be cleared.
When the learning/user phrase area is cleared, all of the registered data is deleted. Double-check before clearing the area.

1. Press the [Clear] switch and the [Execute] switch. When the area has been completely cleared, the message “**Clear Completed**” is displayed.

Before clearing the learning/user phrase area

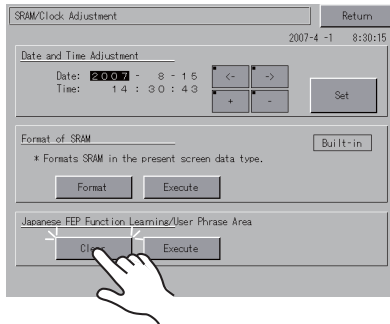

Format of the learning/user phrase area completed

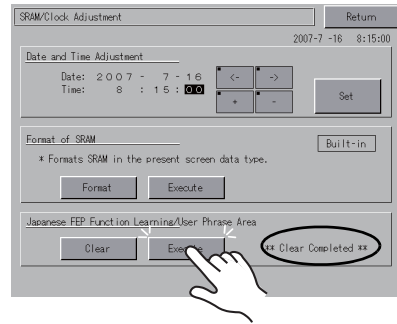

2. Pressing the [Return] switch displays the Main Menu screen again.

6. Extension Program Information

Pressing the [Extension Program Info.] switch on the Main Menu drop-down window brings up the Extension Program Info. screen. This screen is used for checking program versions of the ladder transfer function, printer, Japanese FEP function, simulator, etc.

Main Menu drop-down window

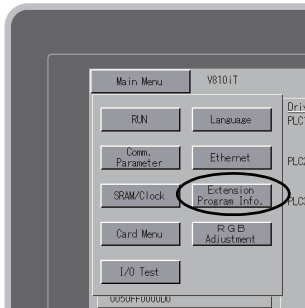

Extension Program Info. screen

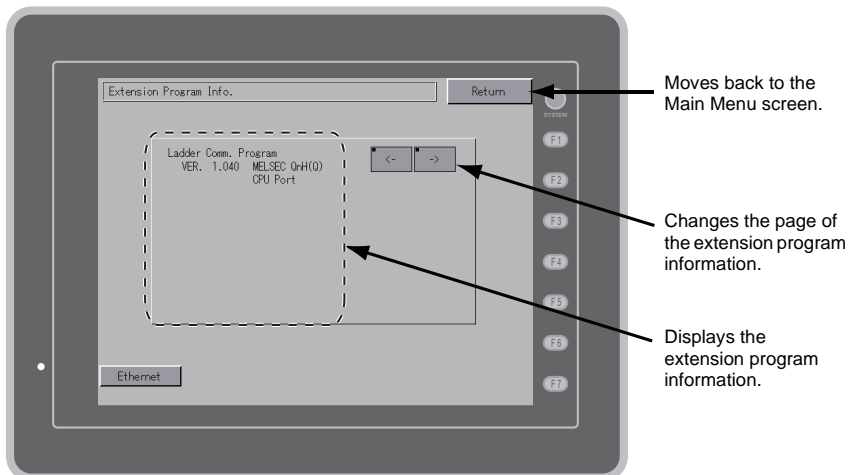

7. Card Transfer

Pressing the [Card Menu] switch on the Main Menu drop-down window brings up the Card Transfer screen.

This screen is used to transfer screen data between the V8 series and a CF card or a memory card.

Main Menu drop-down window

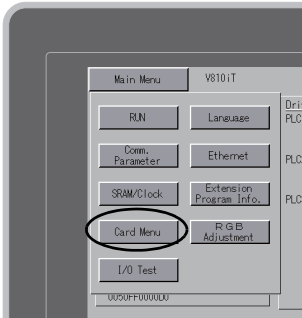

Card Transfer screen

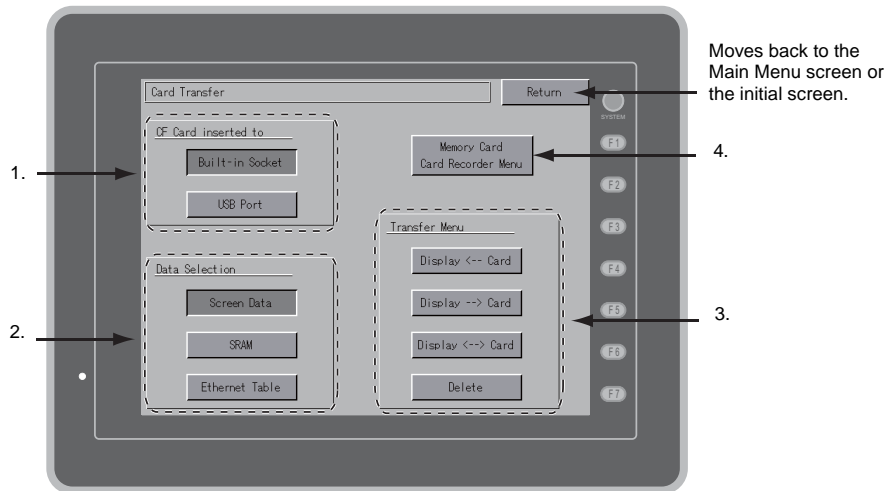

1. [CF Card inserted to] field

- [Built-in Socket]
Press this switch when using the built-in CF card connector on the V8 series.
- [USB Port]
Press this switch when using a CF card while a USB-CFREC (optional) is connected to the USB-A (master port).

2. [Data Selection] field
 - [Screen Data]
Press this switch when transferring screen data using a CF card.
 - [SRAM]
Press this switch when saving backup data in the SRAM memory or when uploading the backup data from the CF card to the V8 series.
 - [Ethernet Table]
Press this switch when transferring the Ethernet table (where an IP address for a PLC etc. is registered) set on the V-SFT-5 editor using a CF card.
3. [Transfer Menu] field
 - [Display <--- Card]
Transfers data from a CF card to the V8 series.
 - [Display ---> Card]
Transfers data from the V8 series to a CF card.
 - [Display <--> Card]
Compares data stored in the V8 series and that stored on the CF card.
 - [Delete]
Deletes data on the CF card.
4. [Memory Card Recorder Menu] switch
Press this switch when connecting the card recorder "CREC" (optional) to the MJ port of the V8 series and transferring screen data between the V8 series and a memory card.
For more information, refer to "Transferring Data to the Card Recorder" (page 5-28).

7-1. Folder Configuration in the CF Card

CF Card Folder Configuration

Folders in the CF card are configured as shown below.



CF Card

 DAT0000 Access folder *¹

Folder Name * ² (Fixed)	Contents	File Name
BITMAP	Pattern (bitmap) data (Reduces the screen data capacity.)	BMPxxxx.BIN
CARD	Recipe data using the V6-compatible memory manager function	MCMHEAD.BIN MCMxxxx.BIN
DSP	Screen data Ethernet table	DSP0000.BIN xxxxxxx.CSV
FONT	Gothic fonts or language data (Reduces the screen data capacity.)	xxxxx.FTD
HDCOPY	Hard copy image (JPEG file format)	HDxxxx.JPG HDxxxx.BIN
JPEG	JPEG file	xxxxx.JPG JPxxxxx.JPG
MEMO	Memo pad data	MEMxxxx.BIN
MSG	Messages (Reduces the screen data capacity.)	MSGxyyy.BIN MSGxyyy.TXT
OPELOG	Operation log data	OPELOG_xyxyz.BIN
RECIPE	Recipe data	RExxxx.CSV xxxxxxx.CSV
SAMPLE	Data of data logging and alarm history	SMPxxxx.BIN SMPxxxx.CSV
SCRN	Screen 3D part Windows font data (Reduces the screen data capacity.)	SCHEADER.BIN SCxxxx.BIN MCRxxxx.BIN MSGxxxx.BIN 3Dxxxx.BIN WFSxxxx.BIN WFMxxxx.BIN
SNAP	Video snapshot images	VDxxxxx.JPG
SRAM	Backup copy of data in the SRAM	SRM0000.BIN
WAV	WAV files for sound output (Reduces the screen data capacity.)	WAxxxx.WAV
WEBSERV	Files to be accessed from the Web browser	xxxxxxx.SHT xxxxxxx.HTM xxxxxxx.TXT

 DSPDEF Screen data auto upload folder *³

Folder Name (Fixed)	Contents	File Name
DSP	Stores screen data for auto-uploading.	DSPDEF.BIN

 TEST*¹
 BITMAP
 CARD

*¹ This is an access folder set on the V-SFT-5 editor. Any folder name within 32 one-byte characters can be given.

*² These folders are automatically created when the access folder is created. The folder name cannot be changed.

*³ The folder name for screen data auto uploading cannot be changed.

7-2. Transferring Screen Data

The procedure for transferring data when a CF card is inserted into the built-in socket of the V8 series is described below.

1. Mounting the CF card

Open the CF card interface cover and insert a CF card into the connector at the rear of the V8 unit.

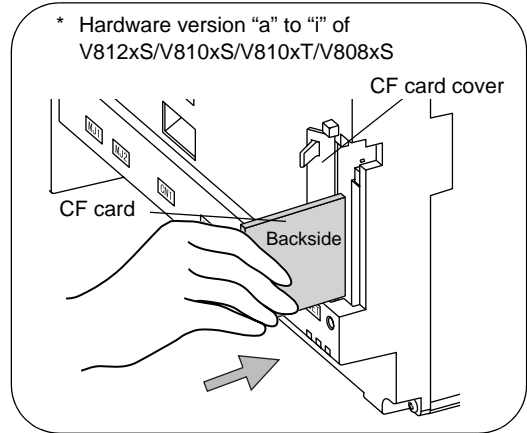
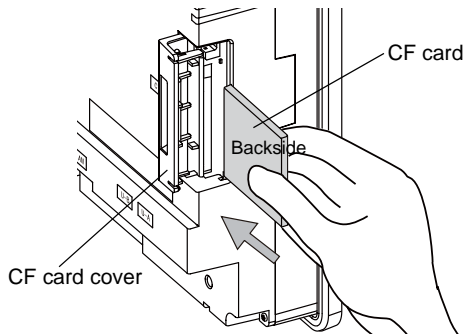

* Do not remove or insert the CF card in the later steps.

2. Displaying the Card Transfer screen

Press the [Card Menu] switch on the Main Menu drop-down window displayed from the Main Menu screen. The Card Transfer screen is displayed.

3. Selecting CF card location and data to be transferred

Select [Built-in Socket] in the [CF Card inserted to] field and [Screen Data] in the [Data Selection] field.

Card Transfer screen

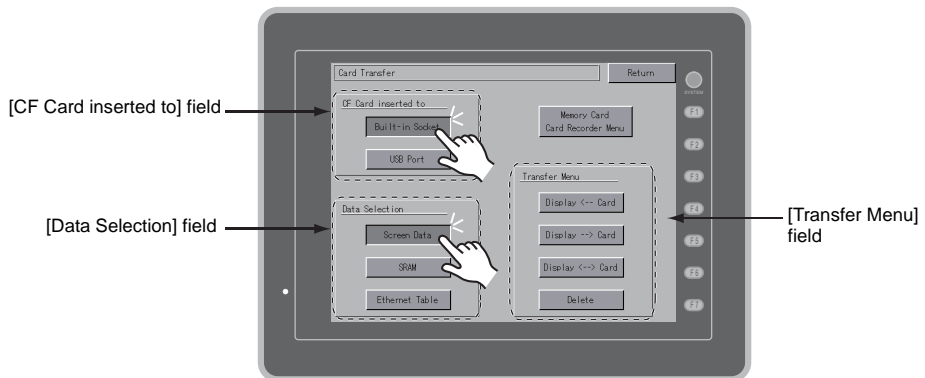

4. Transfer selection

- For details, refer to "When [Display <-- Card] Is Selected:" (page 5-19).
- For details, refer to "When [Display --> Card] Is Selected:" (page 5-22).
- For details, refer to "When [Display <--> Card] Is Selected:" (page 5-23).

When [Display ← Card] Is Selected:

1. When [Display ← Card] is selected, the Card Transfer screen is displayed.

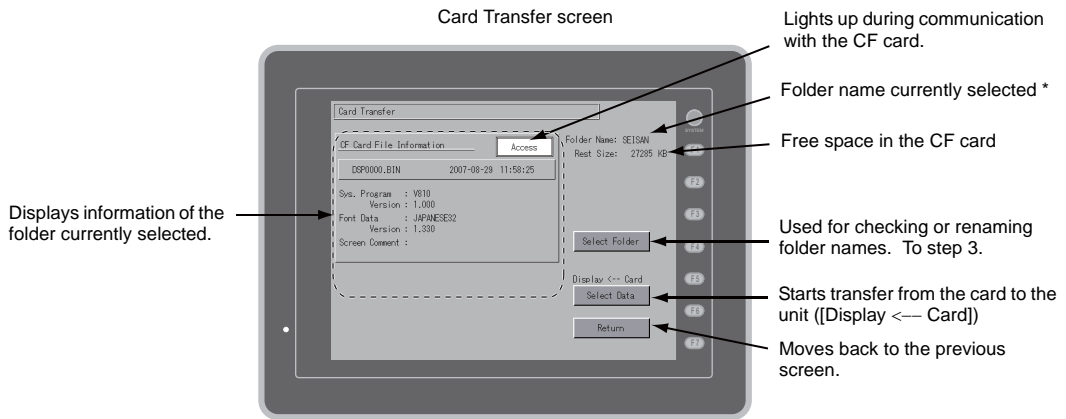

* The access folder name that is set for screen data is displayed as default. If there is no screen data in the V8 series, "DAT0000" is displayed.

2. Checking the access folder
Check the contents of [Folder Name], [Rest Size], and [CF Card File Information]. If the correct folder is selected, go to step 4. To change the folder, go to step 3.
3. Changing the access folder (file check in the folder)
To change the access folder to another, press the [Select Folder] switch.
The Select Folder screen is displayed. Select the desired folder and press the [OK] switch.

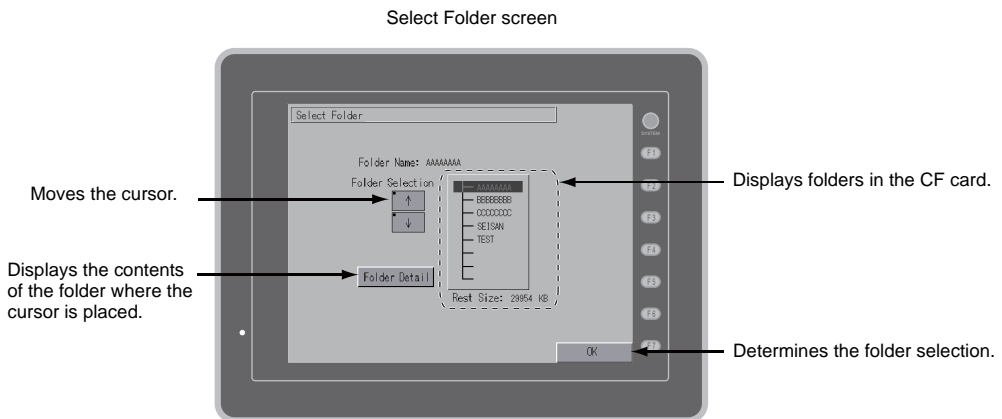

Pressing the [Folder Detail] switch displays the contents of the folder where the cursor is placed.

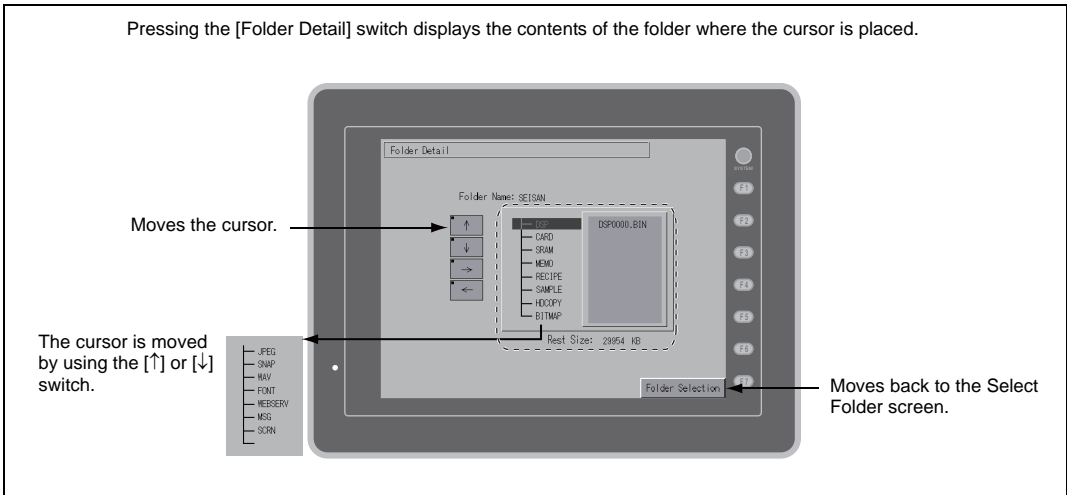

Moves the cursor.

The cursor is moved by using the [↑] or [↓] switch.

Moves back to the Select Folder screen.

4. Data selection to be transferred

After selecting the folder, press the [Select Data] switch.

The [Data Selection] dialog is displayed, and the [Select Data] switch changes to [Start].

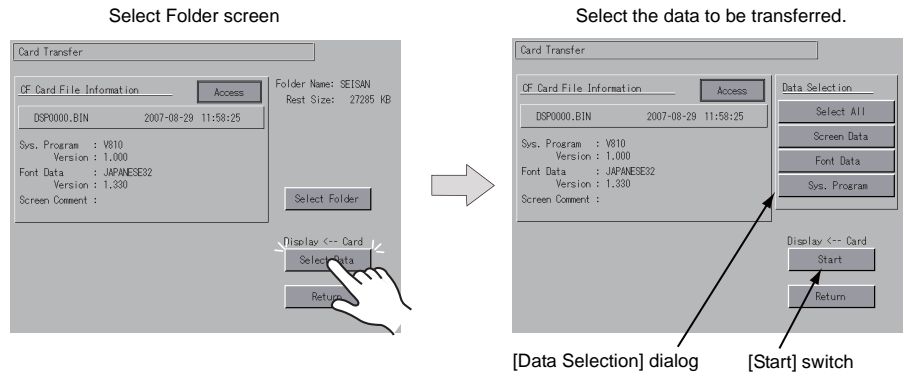

* To cancel the [Data Selection] dialog, press the [Return] switch.

5. Starting data transfer

Select the desired data, and press the [Start] switch. During data transfer, the [Start] switch changes to [Transferring].

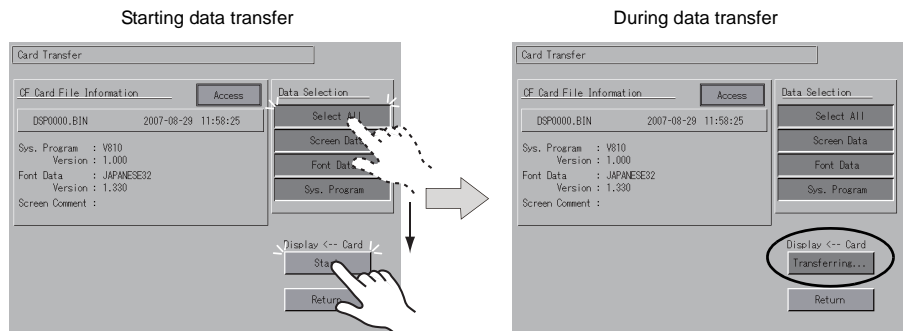

- Data transfer completed
When the data has been transferred successfully, the following message dialog is displayed. Press the [OK] switch.
If the [Sys. Program] or [Select All] switch was selected on the [Data Selection] dialog, the Main Menu screen is automatically displayed on completion of data transfer.

Data transfer completed

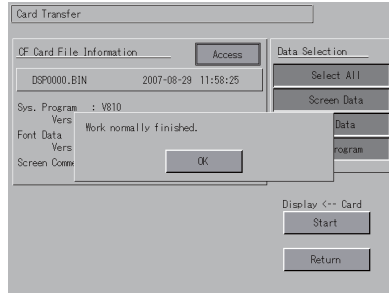

- * If any other message is displayed, refer to "Message Dialog Displayed during Data Transfer (between V8 and Card)" (page 5-30).

When [Display → Card] Is Selected:

1. When [Display → Card] is selected, the Card Transfer screen is displayed.

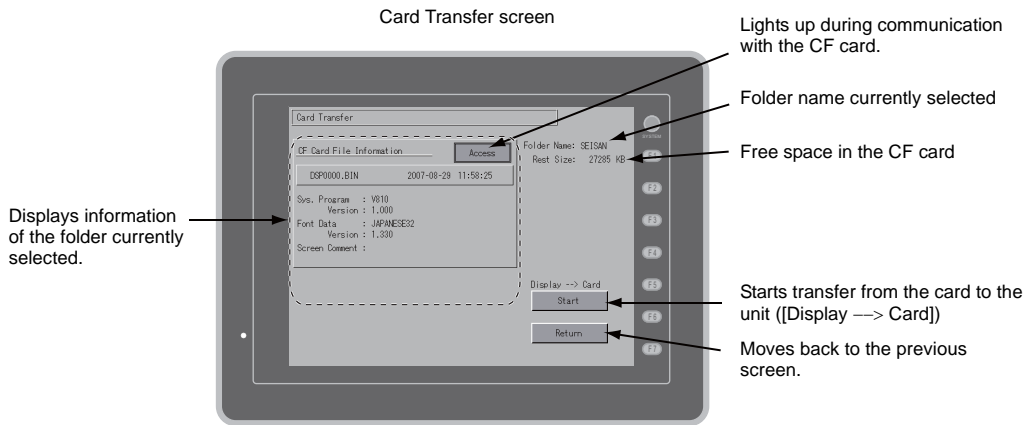

2. Starting data transfer

Check the folder name and CF card file information, and press the [Start] switch.

- * Note that data on the CF card is overwritten if the access folder name of screen data is the same as that in the CF card.

When the CF card file information is blank, a new file "DSP0000.BIN" is created in the DSP folder under the access folder.

3. During data transfer → data transfer completed

During data transfer, the [Start] switch changes to [Transferring]. When data has been transferred successfully, the following message dialog is displayed. Press the [OK] switch.

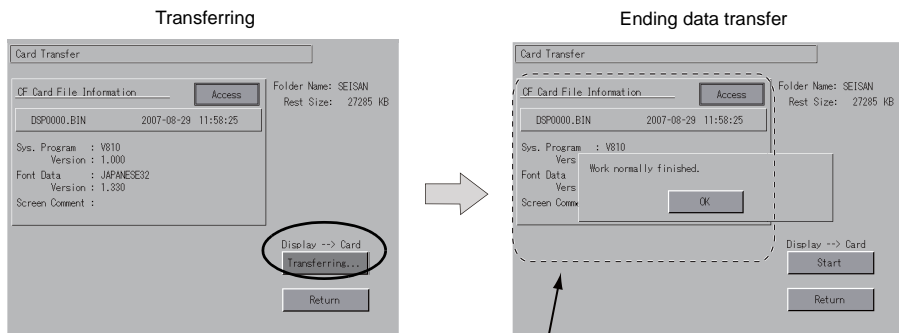

The [CF Card File Information] field shows the data that has been transferred.

- * If any other message is displayed, refer to "Message Dialog Displayed during Data Transfer (between V8 and Card)" (page 5-30).

When [Display <--> Card] Is Selected:

- When [Display <--> Card] is selected, the Card Transfer screen is displayed.
The screen data in the unit is compared with the one in the access folder (in the DSP folder).

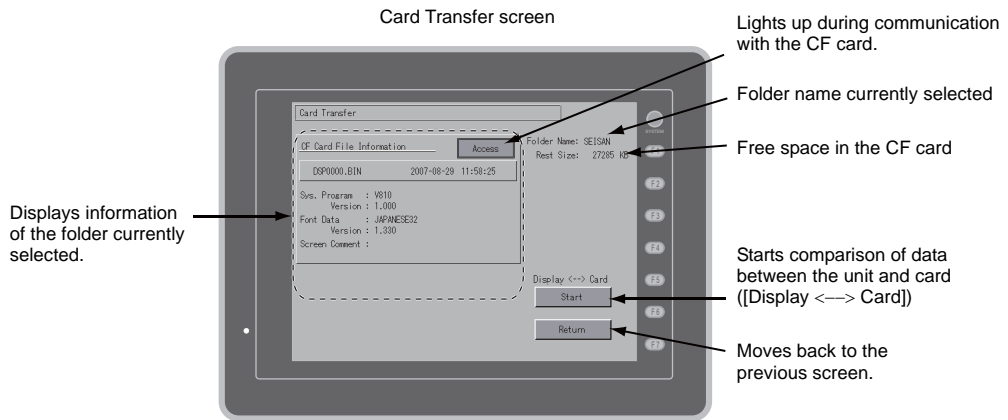

- Starting data comparison
Press the [Start] switch.
- During data comparison → data comparison completed
During data comparison, the [Start] switch changes to [Transferring]. When data comparison has been completed successfully, the following message dialog is displayed. Press the [OK] switch.

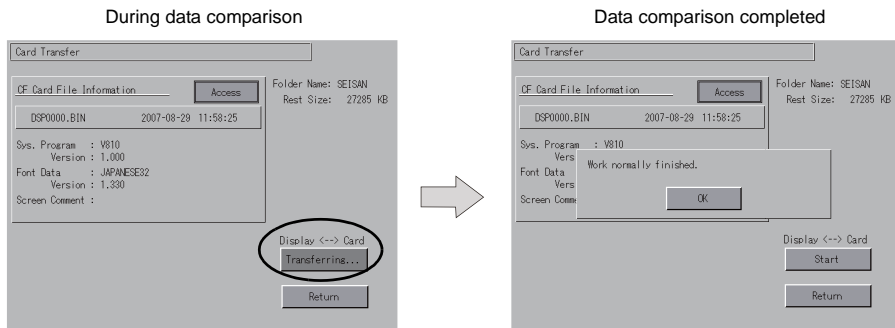

- * If any other message is displayed, refer to “Message Dialog Displayed during Data Transfer (between V8 and Card)” (page 5-30).

7-3. Saving Backup Copies of SRAM

This section explains the procedure for saving backup copies of the SRAM memory for battery replacement.

1. Data selection
Press the [SRAM] switch on the Card Transfer screen. When the switch is pressed, it is selected.
2. Transfer selection
Select [Display ←→ Card], [Display →→ Card] or [Display ←←→ Card] in the [Transfer Menu] field.

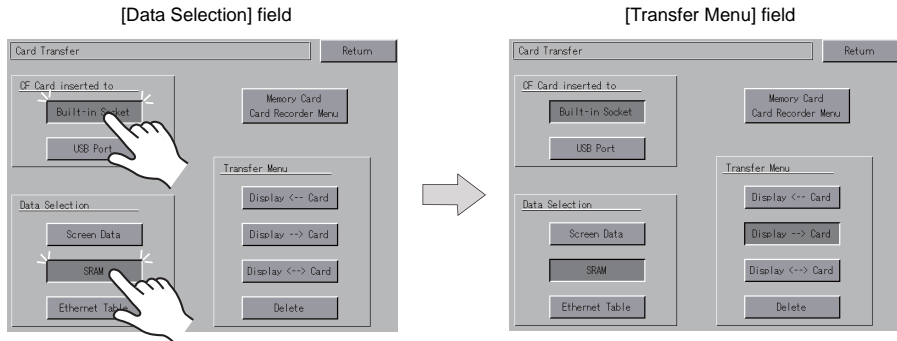

3. Checking or selecting the access folder
The SRAM Transfer screen is displayed.
 - When [Display →→ Card] or [Display ←←→ Card] is selected:
Select the CF card folder having the same name as the access folder for screen data in the V8 series. The name is shown on the screen.

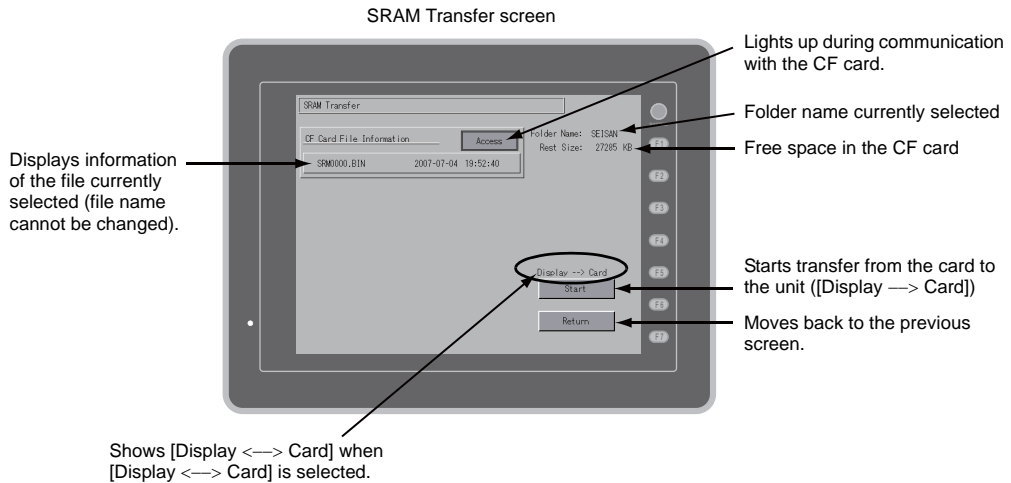

- When [Display ← Card] is selected:

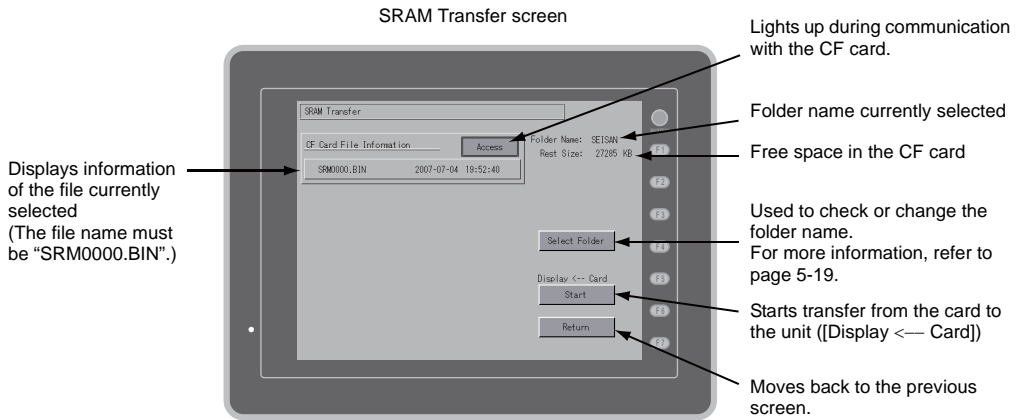

4. Starting data transfer or comparison

Check the folder name, free space and transfer menu, press the [Start] switch. During data transfer or comparison, the [Start] switch changes to [Transferring].

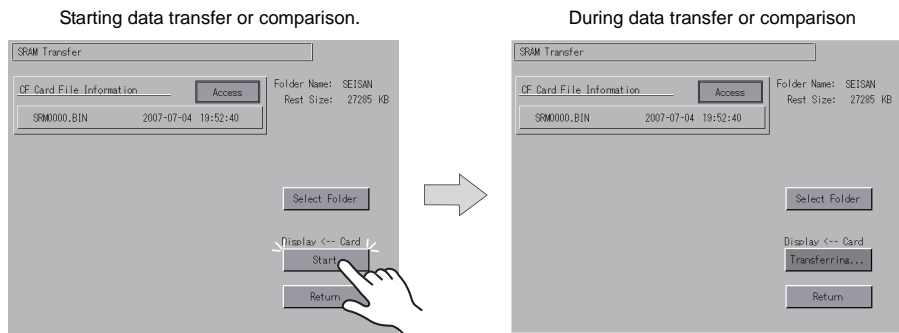

5. Data transfer completed

When data has been transferred successfully, the following message dialog is displayed. Press the [OK] switch.

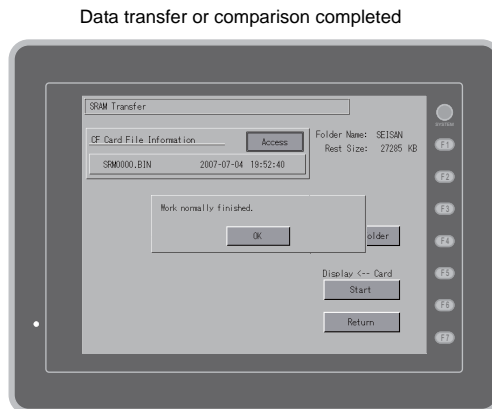

* If any other message is displayed, refer to "Message Dialog Displayed during Data Transfer (between V8 and Card)" (page 5-30).

7-4. Transferring Ethernet Table (Under Development)

This section explains the procedure for transferring the Ethernet table (CSV file format *) that has been stored in the CF card on the V8 series.

* The CSV file is stored in the DSP folder under the access folder in the CF card. For more information, refer to the V8 Series Reference Manual.

1. Data selection
Press the [Ethernet Table] switch on the Card Transfer screen. When the switch is pressed, it is selected.
2. Transfer selection
Select [Display <← Card], [Display → Card] or [Display <↔ Card] in the [Transfer Menu] field.
3. Displaying the Ethernet Table Transfer screen
The Ethernet Table Transfer screen is displayed.
 - When [Display <← Card] is selected:
[Transferring Source] is displayed in the [CF Card File Information] field.
 - When [Display → Card] is selected:
[Transferring Target] is displayed in the [CF Card File Information] field.
 - When [Display <↔ Card] Is Selected:
[Transferring Source] is displayed in the [CF Card File Information] field.
4. File selection
Select a file using the [↑] or [↓] switch. ("-----" is displayed as default (file is not selected).)
5. Starting data transfer or comparison
Press the [Start] switch. During data transfer or comparison, the [Start] switch changes to [Transferring].
6. Data transfer completed
When the data has been transferred successfully, the message "Work normally finished." is displayed. Press the [OK] switch.

* If any other message is displayed, refer to "Message Dialog Displayed during Data Transfer (between V8 and Card)" (page 5-30).

7-5. Deleting Data on the CF Card

Data on the CF card can be deleted. To delete the data, follow the procedures described below.

1. Transfer selection

Selecting [Delete] in the [Transfer Menu] field displays the Delete Data in CF Card screen. To move back to the previous screen, press the [Return] switch.

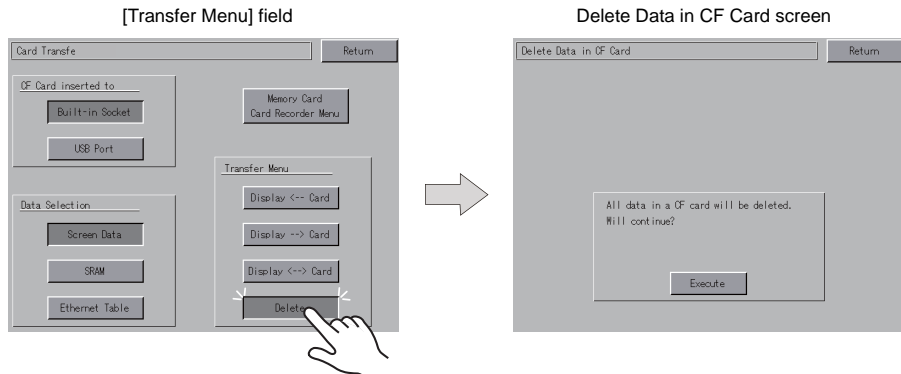

2. Execution of data delete → during execution

Press the [Execute] switch if deleting all data on the CF card. The switch is lit for a while.

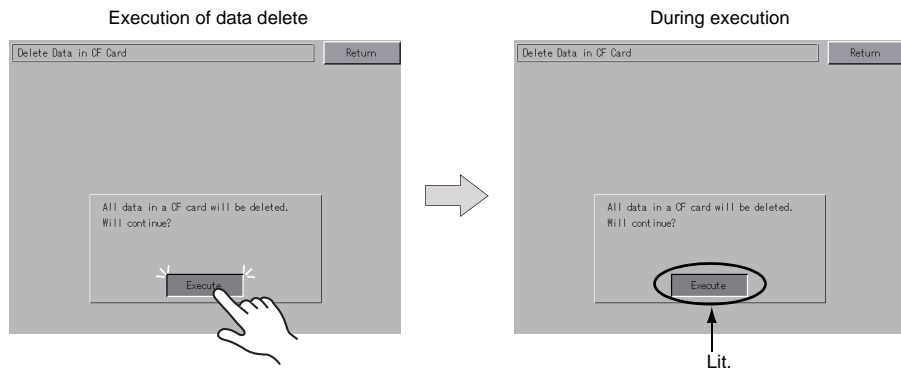

3. Data delete completed

When the data has been completely deleted, the message "Deleting Completed" is displayed. Data is completely deleted. Press the [Return] switch. The Card Transfer screen is displayed again.

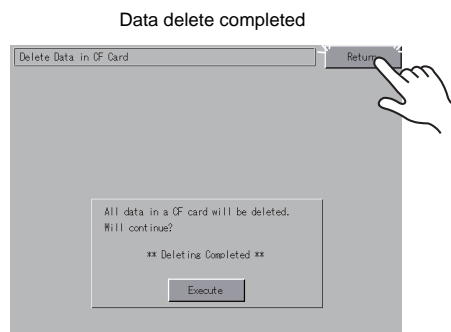

* The data on the CF card is completely deleted; however, when the Main Menu screen is displayed again by the [Return] switch, the access folder for the screen data that has been transferred to the V8 is automatically created.

7-6. Transferring Data to the Card Recorder

When the [Memory Card/Card Recorder Menu] switch is pressed on the Card Transfer screen, the Card Recorder Menu screen appears. This screen is used to transfer screen data between the V8 series and a memory card.

The transfer procedure is explained below.

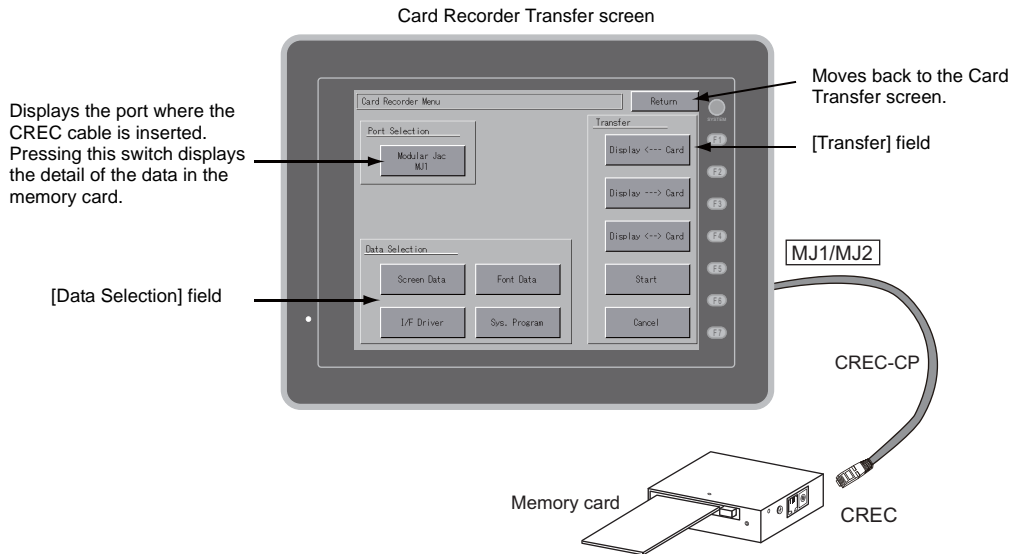

1. Connecting the card recorder "CREC"
Connect the CREC cable "CREC-CP" to the MJ port that is displayed in the [Port Selection] field.

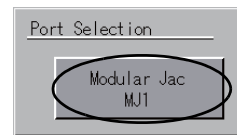

2. Mounting a memory card
Insert a memory card into the card recorder "CREC".
3. Displaying the [Memory-Card Information] field
Pressing the [Modular Jack/MJ1 (MJ2)] switch in the [Port Selection] field displays the [Memory-Card Information] field.
Switches in the [Data Selection] field and the [Transfer] field become active.

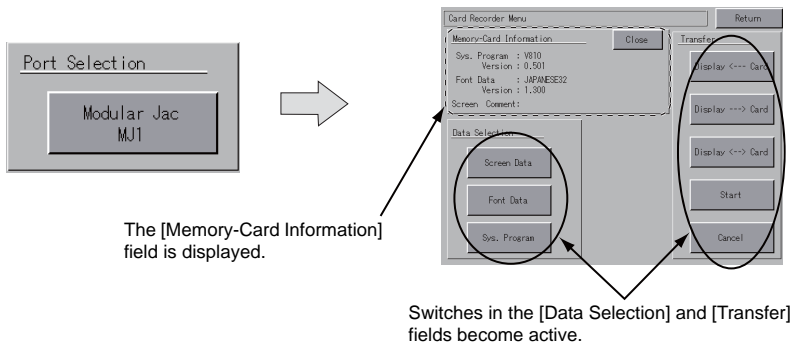

4. Data and transfer selection
Select necessary items in the [Data Selection] and [Transfer] fields.

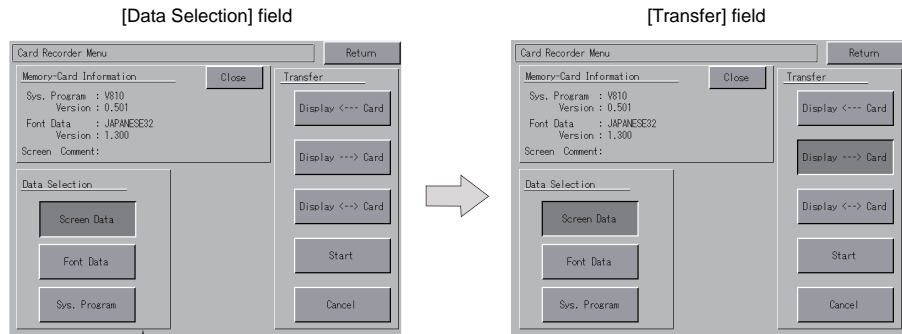

Multiple items can be selected in the [Data Selection] field.

5. Data transfer start → data transfer completed
Press the [Start] switch. During data transfer, the [Start] switch changes to [Transferring]. When data has been transferred successfully, the following message dialog is displayed. Press the [OK] switch.

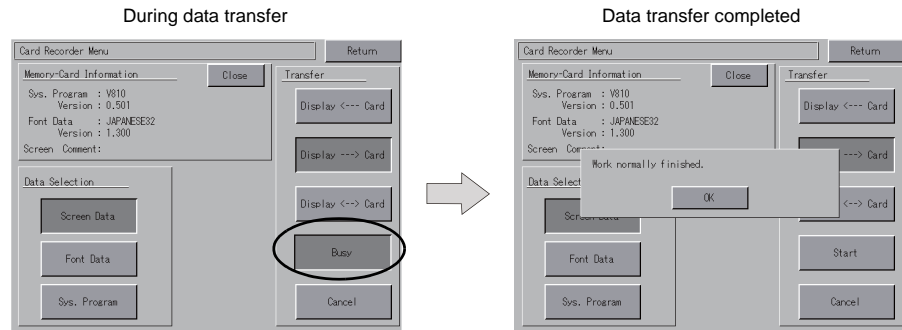

* If any other message is displayed, refer to page 5-30.

7-7. Message Dialog Displayed during Data Transfer (between V8 and Card)

If an error occurs during data transfer, the message dialog shown on the right is displayed.

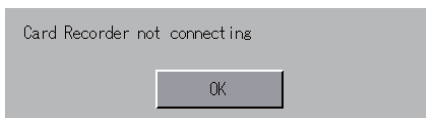

The kinds and the contents of the messages are shown below.

Messages	Contents	CF Card	Memory Card
Work normally finished.	The specified operation has been concluded normally.	○	○
Card Recorder not connecting	No card recorder is connected when selecting a modular jack.	–	○
Card Recorder Communication Error	A communication error occurred between the V8 and the card recorder when selecting a modular jack.	–	○
Card not setting	Card is not inserted.	○	○
Card Capacity over	Cannot write the data into a card because the data size in the V8 unit is larger than the capacity of a card.	○	○
Write Protect : ON	Cannot write data into a card because the write protect switch in a card is ON.	–	○
Writing Error occurred.	The error occurred while writing data into a card.	○	○
Selected data does not exist.	The data in the reading target does not exist.	○	○
Data type is different.	The specified type of the data in the V8 unit is different from the type of the card data.	○	○
Selected data can not be read.	The data in a card cannot be read.	○	○
Reading Error occurred.	The error occurred during writing data into a flash ROM of the V8 unit.	○	○
Data discrepant	There is some discrepancy in data, when comparing the data between a card and the V8.	○	○
Screen data on V8 will be broken.	Warning about data destruction in V8 that may occur when transferring font data larger than the present data from a card to V8. (The [OK] switch continues transferring; the [Cancel] switch stops transferring.)	○	○
Cover for CF card is opened.	The CF card interface cover is opened.	○	–
Undefined Error occurred.	The error occurred due to some cause other than those mentioned above.	○	○
Invalid format.	The filesystem of the CF card or USB thumb drive cannot be recognized. Format these devices to FAT or FAT32 on a computer.	○	–

8. RGB Adjustment

Pressing the [RGB Adjustment] switch on the Main Menu drop-down window brings up the RGB Adjustment screen. This screen is used to adjust the display position on the V8 series so that the display of Windows screen, BIOS screen, or DOS screen of different frequency for RGB output will be displayed in the correct position.

Main Menu drop-down window

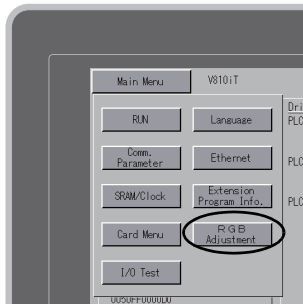

RGB Adjustment screen

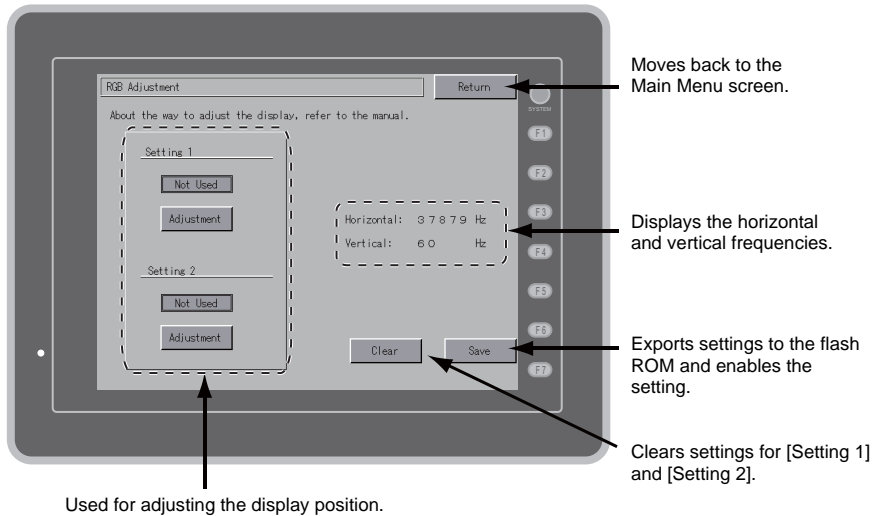

* The [RGB Adjustment] switch is displayed when the optional unit "GU-01", "GU-10", or "GU-11" is mounted on the V812i/V810iS/V810iT/V808iS series.

8-1. Adjusting the Display Position of the RGB Screen

If two types of output frequencies are used, make settings for both [Setting 1] and [Setting 2]. If one type is used, make a setting for either of [Setting 1] or [Setting 2]. The procedure for adjusting the display position of the BIOS screen for [Setting 1] and the one of the Windows screen for [Setting 2] is explained below.

1. Displaying the BIOS screen in RGB color

Display the BIOS screen on the computer. Press the [Adjustment] switch for [Setting 1] to display the BIOS screen in RGB color.

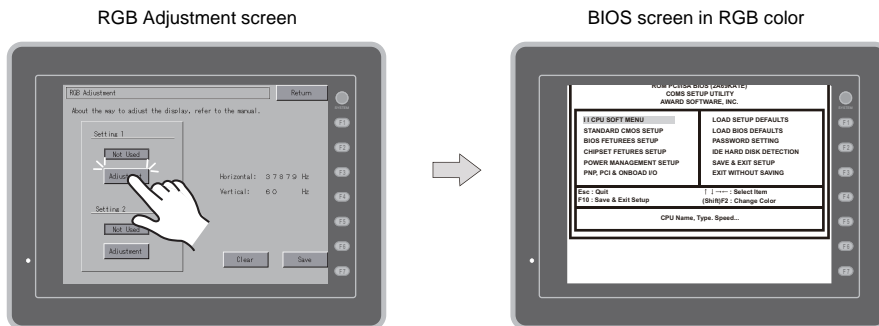

2. Adjusting the display position of the BIOS screen
Adjust the display position using the [F1] to [F4] switches.

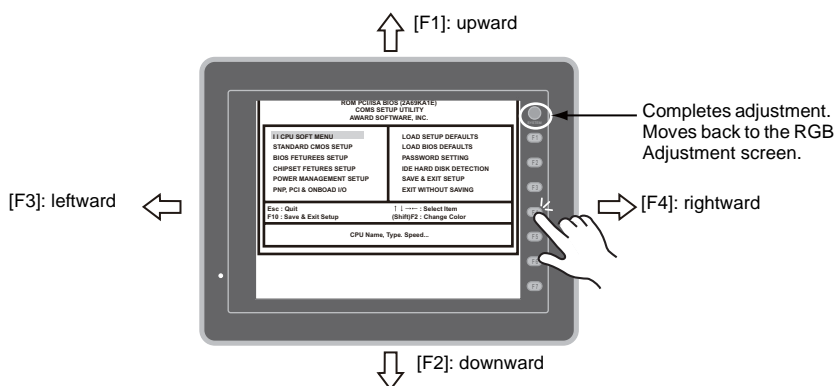

3. Adjustment completed

When the position has been adjusted, press the [SYSTEM] switch. The RGB Adjustment screen is displayed again. The [Used] lamp for [Setting 1] comes on.

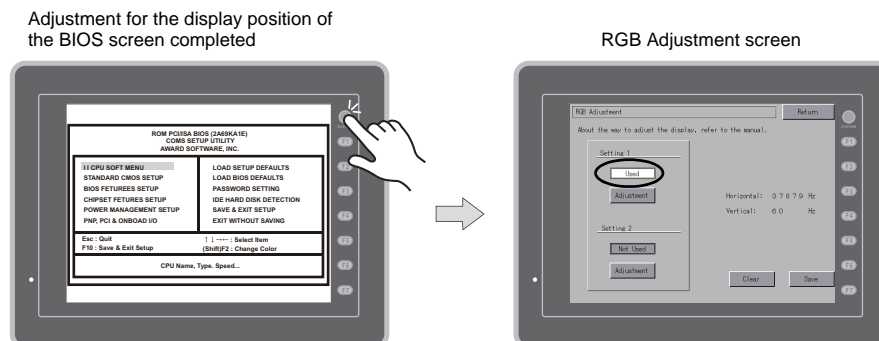

4. Displaying the Windows screen in RGB color
Display the Windows screen on the computer. Press the [Adjustment] switch for [Setting 2] to display the Windows screen in RGB color.

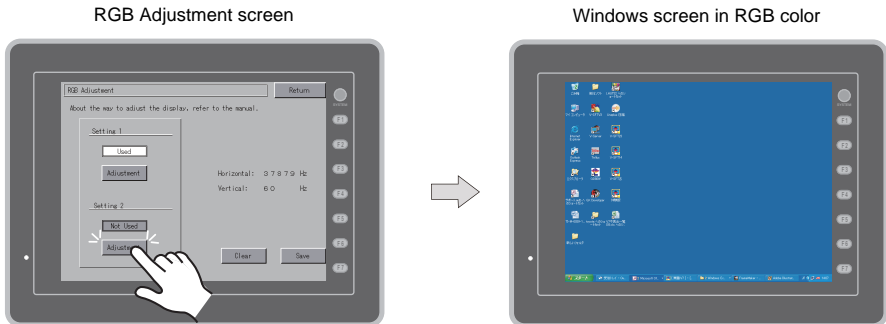

5. Adjust the display position using the [F1] to [F4] switches. For the procedure for adjusting the display position, see step 2.
6. When the position has been adjusted, press the [SYSTEM] switch. The RGB Adjustment screen is displayed again. The [Used] lamp for [Setting 2] comes on.
7. Press the [Save] switch to save the setting. When the setting has been saved, the Main Menu screen is automatically displayed. Settings are stored into the flash ROM, so they are retained when the power is turned off and on.

Setting completed

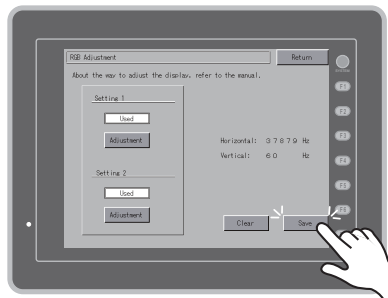

9. I/O Test

Pressing the [I/O Test] switch on the Main Menu drop-down window brings up the I/O Test screen. This screen is used to check that there is no problem with the V8 interfaces and touch switch operation.

Main Menu drop-down window

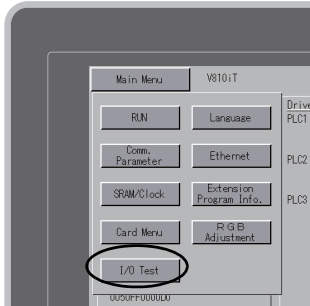

I/O Test screen

Moves to the Touch Switch Test screen. (page 5-42)

Performs a USB connection test. (page 5-40)

Moves back to the Main Menu screen. (page 5-3)

Moves to the Extension I/O screen.*

Moves to the Keyboard Selection screen. (page 5-44)

Moves to the Print Test screen. (page 5-40)

Performs a function switch test. (page 5-41)

Performs a CN1/MJ1/MJ2 interface test. (page 5-35)

* When the serial extension I/O "V-I/O" is connected, you can check that the V-I/O works correctly. The [Ext. I/O Check] switch appears only when [V-I/O] is selected for a modular jack (MJ1/MJ2) on the V-SFT-5 editor.

9-1. Self-loop Test

This is a signal test for communications through the CN1, MJ1 or MJ2 connector. Perform this test if the communication is not successfully established when transferring screen data through MJ1, connecting a controller using CN1, selecting multi-link 2 for MJ1 (or MJ2), or connecting a PLC, temperature controller, card recorder "CREC", or serial extension I/O "V-I/O" for MJ1 (or MJ2).

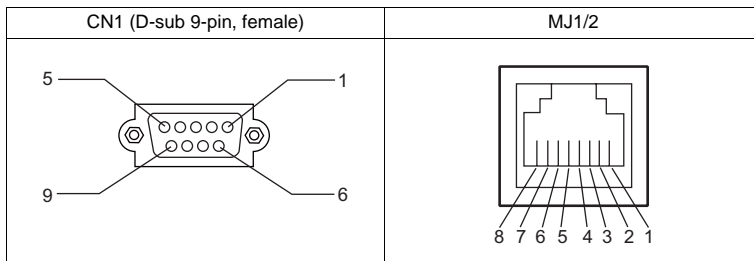

CN1: RS-232C Signal Test

Turn the [CN1] and [RS232C] switches on.

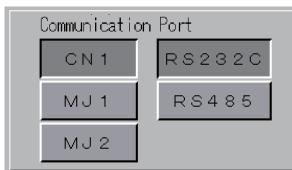

SD/RD Test

Check the signals [SD] and [RD].

1. Install a jumper between pins 2 and 3 of CN1 on the V8 series.

Name	No.
RD	2
SD	3

2. Press the [Self-Loop Test] switch. When the [OK] lamp lights up, the test is successfully completed.

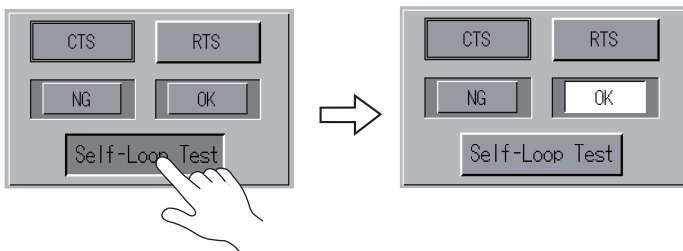

* If the [NG] lamp lights up, pin 2 or 3 may be faulty. Contact your local distributor.

CTS/RTS Test

Check the signals [CTS] and [RTS].

1. Install a jumper between pins 7 (RTS) and 8 (CTS) of CN1 on the V8 series.

Name	No.
RTS	7
CTS	8



2. Press the [RTS] switch and check that both [RTS] and [CTS] lamps light up at the same time. Press the [RTS] switch again and check that both [RTS] and [CTS] lamps go off at the same time.

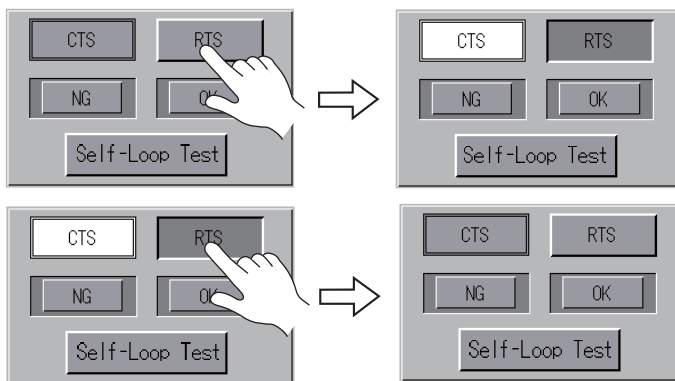

CN1: RS-485 Signal Test

Turn the [CN1] and [RS485] switches on.

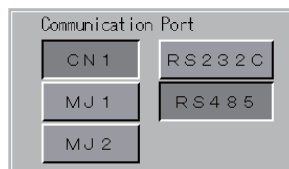

SD/RD Test

Check the signals [SD] and [RD].

1. Install a jumper between pins 1 and 4 and between pins 2 and 3 of CN1 on the V8 series.

Name	No.
+RD	1
-RD	2
-SD	3
+SD	4



- Press the [Self-Loop Test] switch. When the [OK] lamp lights up, the test is successfully completed.

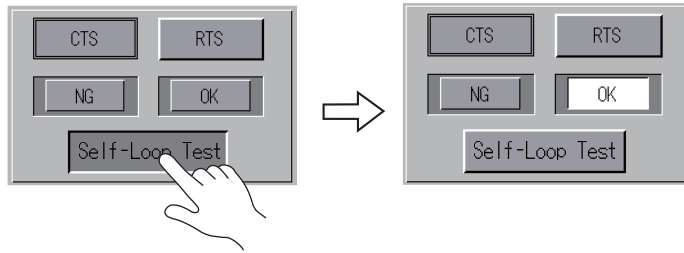

* If the [NG] lamp lights up, a pin may be faulty. Contact your local distributor.

+RTS/-RTS Test

Check the signals [+RTS] and [-RTS].

- Install a jumper between pins 1 (+RD) and 6 (+RTS) of CN1 and between pins 2 (-RD) and 7 (-RTS) on the V8 series.

Name	No.
+RD	1
-RD	2
+RTS	6
-RTS	7

- Press the [RTS] switch and check that both [RTS] and [CTS] lamps light up at the same time. Press the [RTS] switch again and check that both [RTS] and [CTS] lamps go off at the same time.

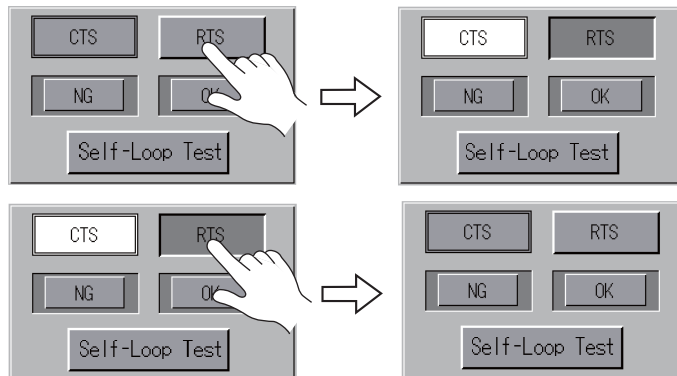

* Since the V8 series does not have [+CTS] nor [-CTS] signal for CN1 (RS-485 connection), a self-loop test should be performed by using [+RD] (pin 1) and [-RD] (pin 2) signals.

MJ1/2: RS-232C Signal Test

Turn the [MJ1] (or [MJ2]) and [RS232C] switches on.

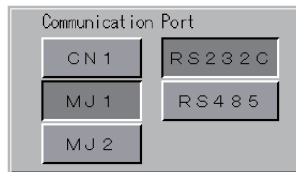

SD/RD Test

Check the signals [SD] and [RD].

1. Install a jumper between pins 7 and 8 of MJ1 (or MJ2) on the V8 series. (*)

Name	No.
RD	7
SD	8

* A signal test can also be performed by inserting "V-CP" into MJ1 (or MJ2) and installing a jumper between pins 2 and 3 on the D-sub 9-pin side of "V-CP".

2. Press the [Self-Loop Test] switch. When the [OK] lamp lights up, the test is successfully completed.

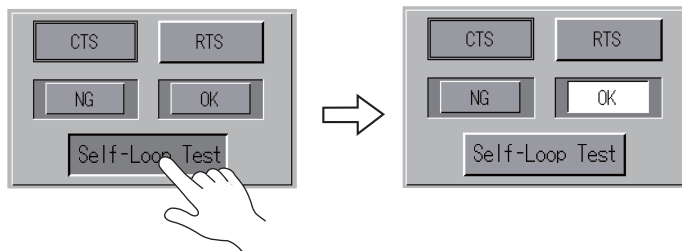

* If the [NG] lamp lights up, consult your local distributor.

MJ1/2: RS-485 Signal Test

Turn the [MJ1] (or [MJ2]) and [RS485] switches on.

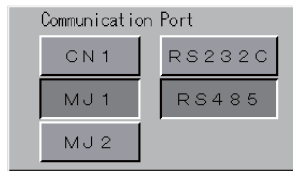

SD/RD Test

Check the signals [SD] and [RD].

1. Install wiring between MJ1 (or MJ2) and CN1 on the V8 series as shown below.

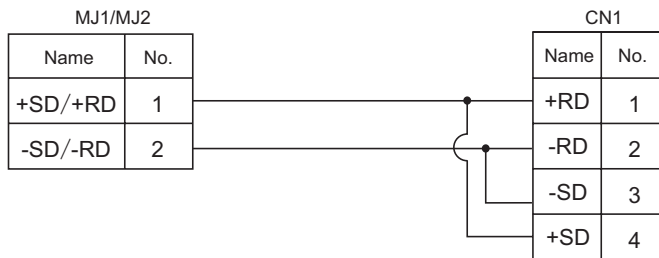

1. Press the [Self-Loop Test] switch. When the [OK] lamp lights up, the test is successfully completed.

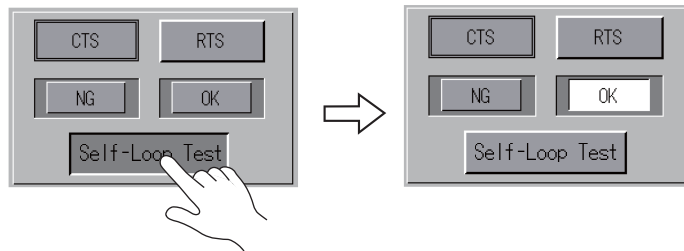

* If the [NG] lamp lights up, a pin may be faulty. Contact your local distributor.

9-4. [SYSTEM] Switch & Function Switch Test

Check operations of eight switches provided vertically on the right side (for V812, horizontally at the bottom) of the panel. Hold down the switch, and check that the lamp on the screen lights up.

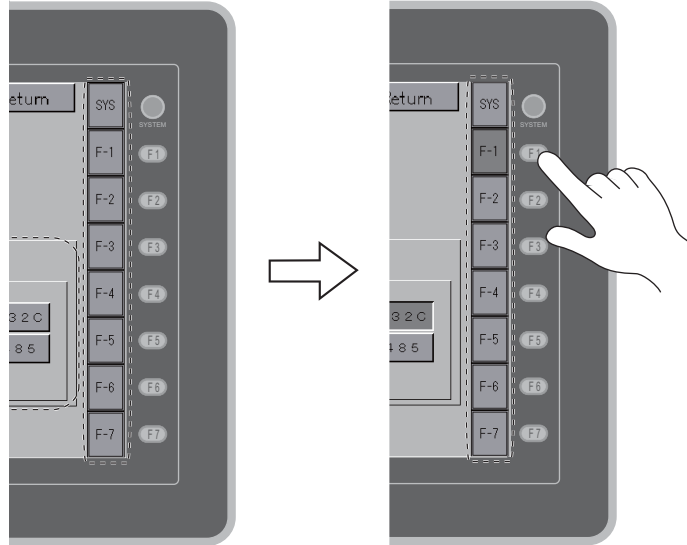

9-5. Touch Switch Test

If a touch switch does not activate at all or if an operation is performed without pressing any touch switch, check that the touch switches on the V8 panel are working properly.

1. Touch switch test screen

Press the [Switch Check] switch. Grids appear on the screen as shown below.

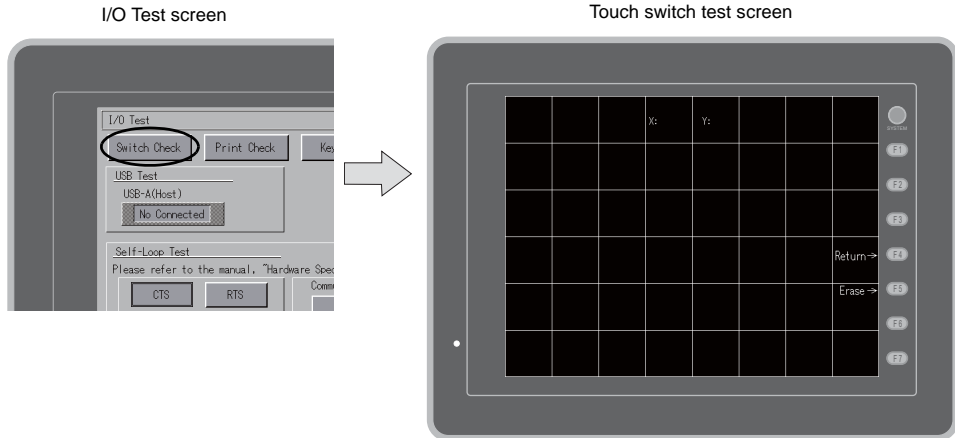

2. Checking the switch output state

Press a position on the panel, and check that the pressed position turns white. The switch is activated normally when the pressed position turns white. To move back to the I/O Test screen, press the [F4] switch.

To delete white dots, press the [F5] switch.

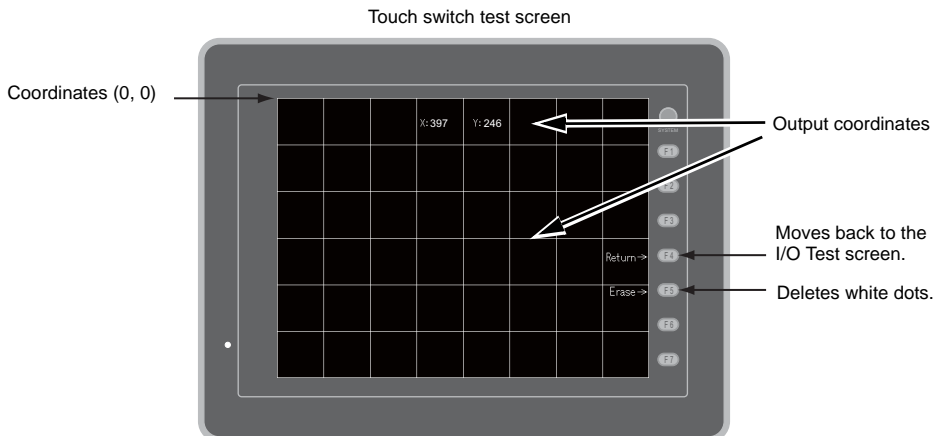

* If a position different from the pressed position turns white, refer to "Touch Switch Adjustment" on the next page and adjust the touch switch position.

Touch Switch Adjustment

If a position different from the pressed position turns white on the touch switch test screen, follow the steps described below to adjust the touch switch position.

1. Hold down the [SYSTEM] switch and press the [F2] switch on the touch switch test screen. The Touch Switch Adjustment screen appears.

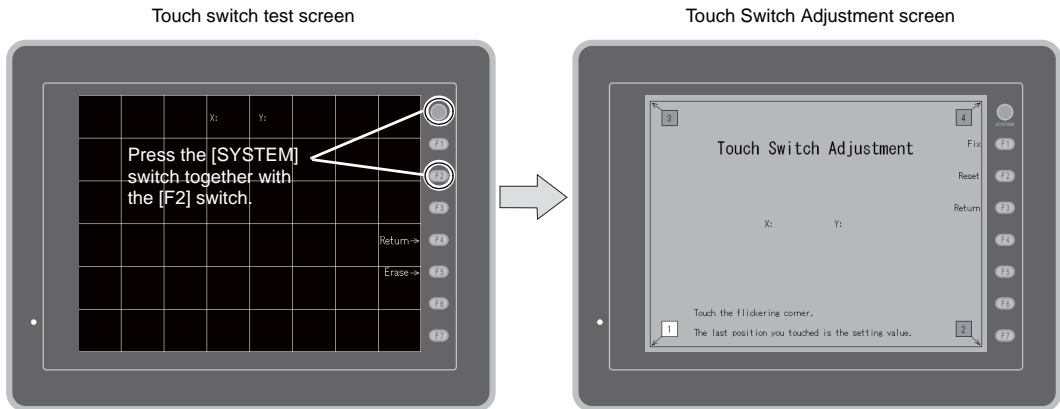

2. Press on "1" that is flashing at the corner. When the finger is released, a beep sounds and the position is set. "2" flashes.
3. Press on "2" that is flashing at the corner. When the finger is released, a beep sounds and the position is set. "3" flashes.
4. Press on "3" that is flashing at the corner. When the finger is released, a beep sounds and the position is set. "4" flashes.
5. Press on "4" that is flashing at the corner. When the finger is released, a beep sounds and the position is set.
6. To re-set the positions, press the [F2] switch and follow step 2 and later.
7. Press the [F1] switch. A long beep sounds and the positions are determined. The touch switch test screen is displayed again.
8. To cancel the setting, press the [F3] switch. The touch switch test screen is displayed again.

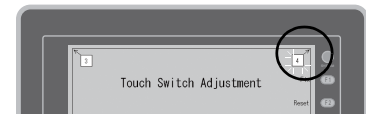
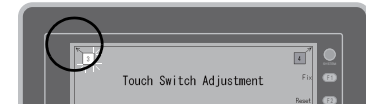
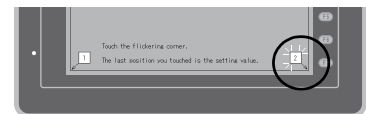
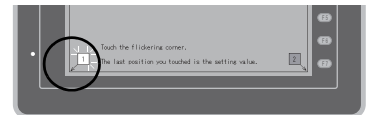

9-6. Keyboard Selection

Set the keyboard type to be connected to the USB-A(master port).

1. [Keyboard Selection] screen
Press the [keyboard] switch. The [Keyboard Selection] screen appears as shown below.

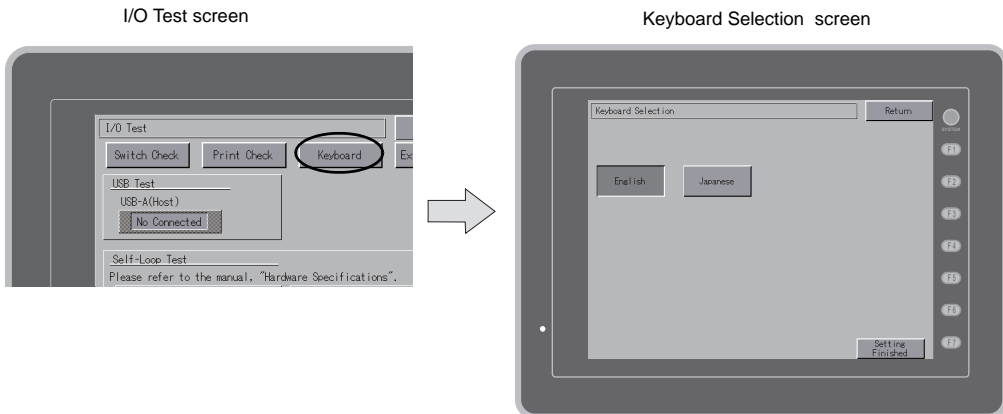

2. Keyboard type setting
Set the keyboard type to be connected to the V8 with [English] and [Japanese] switch.

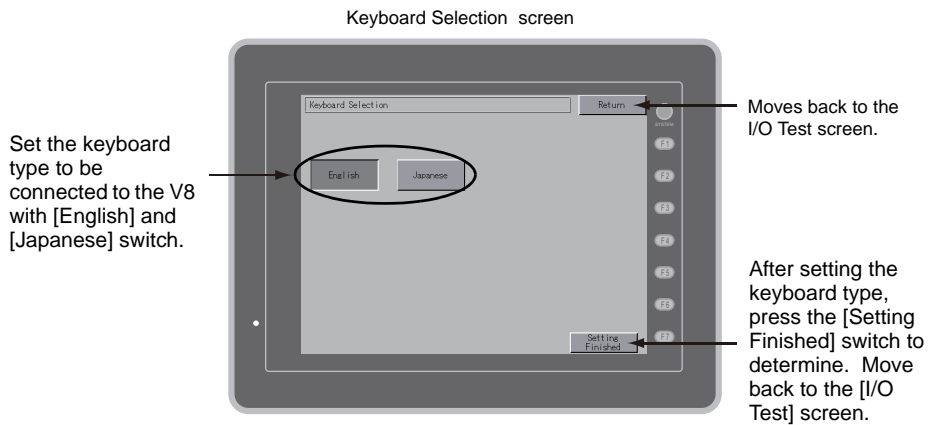

* [English] is set as default.

Once the keyboard type is changed on the [Keyboard Selection] screen, and the [Setting Finished] switch is pressed, the changed type is set even if the power is turned on again.

3. Press the [Setting Finished] switch to determine the keyboard type. Move back to the [I/O Test] screen.

10. Extended Function Setting

Pressing the [Editor: MJ1] switch on the Main Menu screen and the [F5] switch at the same time displays the Extended Function Setting screen. This screen is used to set the baud rate for modem communication and the local port number for V-Link or Modbus slave communication.

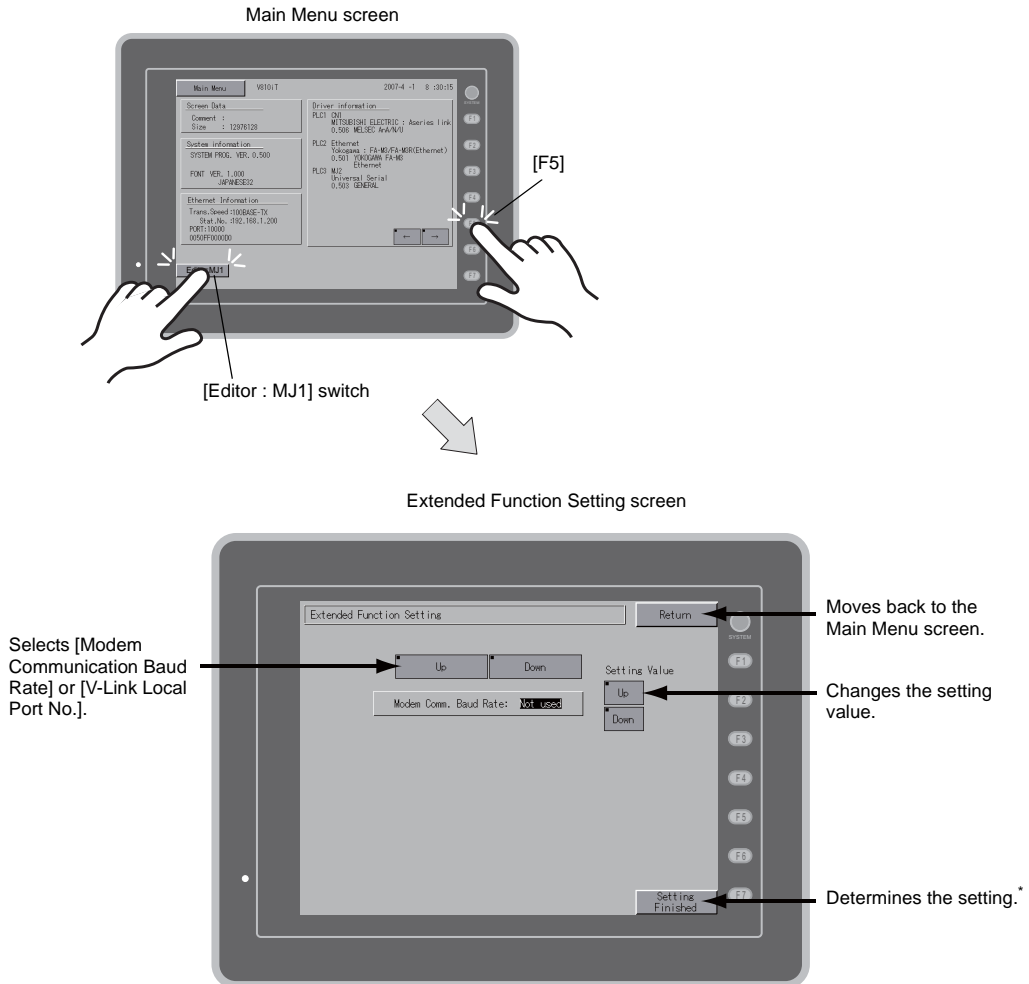

* The function switches and switches on the Main Menu screen are not valid for 15 seconds after the [Setting Finished] switch is pressed.

10-1. Setting Baud Rate between V8 Series and Modem

Set the baud rate to be used when transferring screen data between the V8 series and a modem.

1. Baud rate setting

Select the desired baud rate using the [Up] or [Down] switch, and press the [Setting Finished] switch to determine the setting. The baud rate can be selected from 4800, 9000, 19200, 38400, 57600 or 115200 bps.

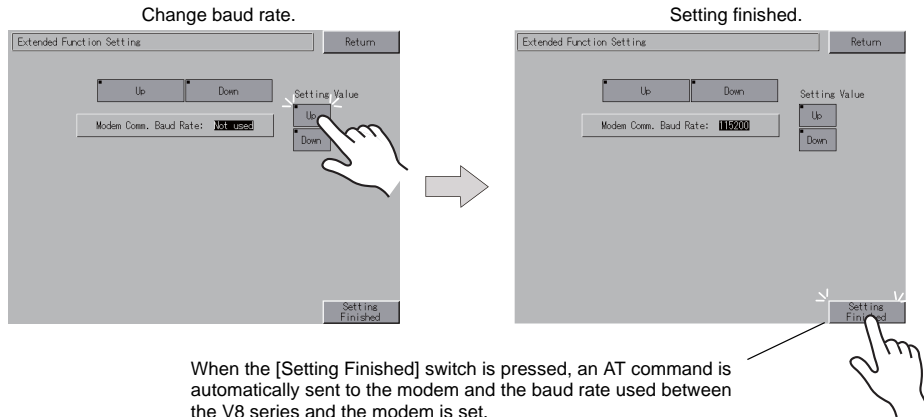

2. Modem communication mode

The Main Menu screen is displayed automatically. [Modem Connect Mode]* automatically appears under [Editor: MJ1].

In the modem communication mode

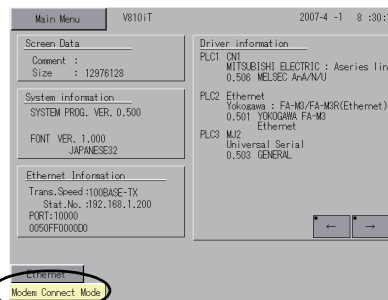

* To transfer screen data without a modem, select "Not Used" for [Modem Comm. Baud Rate]. To transfer screen data by connecting the V8 series and the computer via "V-CP", select "Not used" for [Modem Comm. Baud Rate].

10-2. Setting V-Link Local Port Number

For V-Link communication, set the V-Link local port number on the Main Menu screen. (The V-Link local port number can be set when [Set Local Port No. in Main Menu] is checked in the [Device Connection Setting] dialog ([System Setting] → [Device Connection Setting] → [PLCn: V-Link]).)

1. Displaying the [V-Link Local No.] field
Press the [Down] switch to display the [V-Link Local No.] field.
2. V-Link local port number setting
Set the V-Link local port number using the [Up] or [Down] switch. The V-Link local port number can be selected from 1 to 254. Press the [Setting Finished] switch to complete the setting.

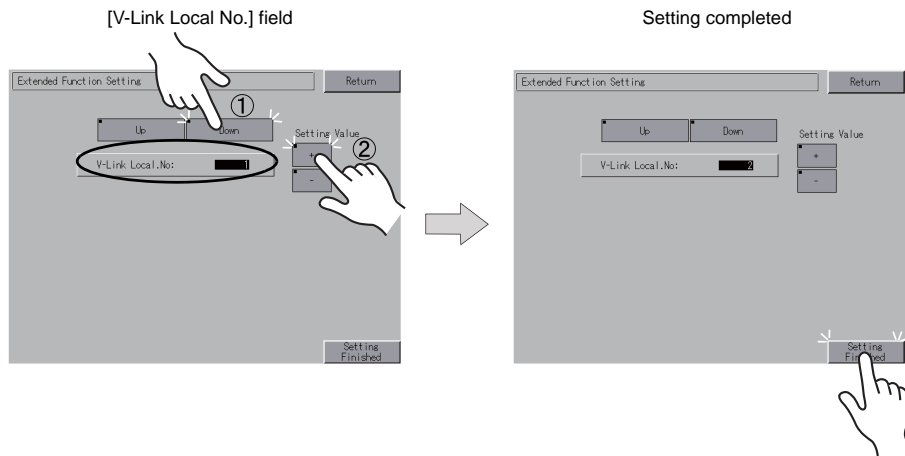

3. The Main Menu screen is automatically displayed again.

10-3. Local Port Number Setting for Modbus Slave Communication

Set the local port number for the Modbus slave communication on the Main Menu screen. (The Modbus slave local port number can be set when [Set Local Port No. in Main Menu] is checked in the [Device Connection Setting] dialog ([System Setting] → [Device Connection Setting] → [PLCn : Modbus Slave (RTU)]).)

- * For the setting procedure, refer to “Setting V-Link Local Port Number”.

MEMO

Please use this page freely.

6 Error Handling

1. Error Messages
2. Troubleshooting

1. Error Messages

There are five kinds of error messages displayed on the V8 series:

1. Communication Error
2. Data Loading
3. Warning
4. SYSTEM ERROR
5. Touch switch is active.

1. Communication Error

When communication is not established between the V8 series and a controller, or any abnormality (noise etc.) is detected, the following messages are displayed on the V8 series.

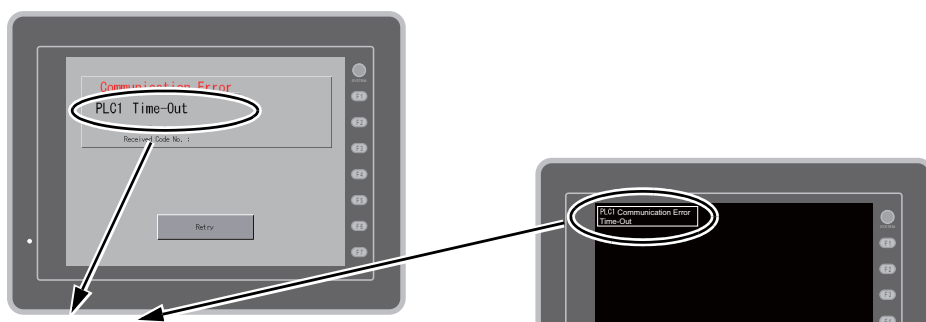

Error Messages	Contents	Solution	Remarks
Time-Out	Although a request to send is given to a controller, no answer is returned within the specified time.	1. Check settings in the [Communication Setting] tab window of the [Device Connection Setting] dialog.	1
		2. Check the cable connection.	2
Parity	An error occurred in parity check.	3. Data may be disrupted because of noise. Fix noise.	2
		1. Check the cable connection.	1
Framing	Although the stop bit must be [1], it is detected as [0].	2. Data may be disrupted because of noise. Fix noise.	2
		1. Check settings in the [Communication Setting] tab window of the [Device Connection Setting] dialog.	1
Overrun	After one character is received, the next character is received before internal processing is completed.	2. Check the cables and wiring.	2
		3. Data may be disrupted because of noise. Fix noise.	2
Check code error	The check code in the controller response was not correct.	1. Check settings in the [Communication Setting] tab window of the [Device Connection Setting] dialog.	1
		2. Data may be disrupted because of noise. Fix noise.	2

* If the above error messages are displayed on the V8 series without establishing communication between V8 and PLC, test the solution of remark "1". If the error occurs suddenly in communication, test the solution of remark "2".

Error Messages	Contents	Solution
Error code received	An error code was sent by a controller. (NAK)	Examine the controller error code and solve the problem.
Break	The controller's SD remains at the low level.	Examine the connection between the controller's SD and the V8's RD.
Invalid memory (Mitsubishi CPU)	You specified an address that exceeds the memory range of the PLC that you are linked to.	Check the type and range of memory that you set.
Invalid CPU model (Mitsubishi CPU)	The PLC currently being supported does not have a corresponding CPU.	Confirm whether or not the CPU that you are using can be used with the V8 series.
Format	The code of the received data is invalid.	<ol style="list-style-type: none"> 1. Confirm link unit settings. (After making settings, cut power to the controller.) 2. On the V-SFT-5 editor, select [System Setting] → [Device Connection Setting] and check the settings. 3. If errors only occur from time to time, a noise-based communication error may be present.
Compare (HIDIC S10)	Transmission data and received data are different.	
NAK	A NAK code is received.	
Transaction Error (Allen-Bradley PLC)	Transmitted transaction data and received transaction data are not in agreement.	
Communication Error	An unclear communication error is detected.	
Count error (Mitsubishi CPU and Q link unit)	The expected data amount is different from the count value.	
Command error (Mitsubishi CPU and Q link unit)	The response code differs from the expected code.	
Invalid cassette (Mitsubishi ACPU)	This cassette is not included in the memory cassettes currently being supported.	Contact your local distributor.
Password error (Mitsubishi QCPU)	The password is incorrect.	

1-1. Error Messages for Network Communication

Ethernet

Error Messages	Contents	Solution
Ethernet Error:XXXX	The Ethernet status is saved at system memory address \$s518 and a code other than "0" (normal) is received. XXXX : Error No.	For the contents and solution to each error number, refer to Appendix 5 of the V8 Series Connection Manual separately provided.

CC-LINK

Error Messages	Contents	Solution
I/F Board Err	The I/F unit for CC-LINK has an error.	Contact your local distributor.
No. of Occupy Setting Err	The number of stations set in the [Communication Setting] tab window of the [Device Connection Setting] dialog is different from the number of stations used by switches.	Check the setting of the number of occupy.
Network I/O Access Err	MONITOUCH has attempted to have access to a memory area out of the designated input/output words.	Check the memory for the network I/O in the screen data file.
Station Number Err	The port number set by a switch is not within the setting range (1 to 64).	Specify the port number within the setting range.
Word Writing to Sp. Relay	Word writing to a special relay (M9000 and later) is attempted. (Notes: Only bit writing is possible for special relays when connecting with CC-LINK.)	Do not attempt to perform word writing to special relays.

OPCN-1

Error Messages	Contents	Solution
I/F Board Err	The I/F unit for OPCN-1 has an error.	Contact your local distributor.
Stat. No. out of range	The port number set by a switch is not within the setting range (1 to 127).	Specify the port number within the setting range.
Network Link Error	Cannot connect to the master station in the network.	Check the condition of the master station (PLC). Check the network connection.
Network I/O Access Err	MONITOUCH has attempted to have access to a memory area out of the designated input/output words.	Check the memory for the network I/O in the screen data file.
Waiting for Reply	<ol style="list-style-type: none"> Less than "Max_int" time (communication monitoring time for salve station) set on the PLC for OPCN-1 communications Timeout on the V8 series (The timeout time can be set in the [Device Connection Setting] dialog that is displayed by selecting [System Setting] → [Device Connection Setting] on the V-SFT-5 editor.) This error is indicated when the above 1 and 2 are present.	When the "Max_int" time is too long (infinite, for example) on the PLC, it is not possible to know whether or not the response from the PLC is correctly made. This error message disappears when a response from the PLC is received within the "Max_int" time.
Word Writing to Sp. Relay (Mitsubishi: A Series)	Word writing to a special relay (M9000 and later) is attempted. (Notes: Only bit writing is possible for special relays when connecting with OPCN-1.)	Do not attempt to perform word writing to special relays.

T-LINK

Error Messages	Contents	Solution
T-LINK I/F Board Err	The I/F unit for T-LINK has an error.	Contact your local distributor.
Network I/O Access Err	MONITOUCH has attempted to have access to a memory area out of the designated input/output words.	Check the memory for the network I/O in the screen data file.
Communication Error Received Code No. 22	The PLC loader is being accessed so that processing is not performed on the V8 series. (This error occurs during program transfer from the PLC loader for most cases.)	Wait for the completion of processing at the PLC loader, and try again.
Communication Error Received Code No. 32	An attempt to access an area that does not exist within the PLC is made. Example: A file area (W) that is not defined with the PLC program	Check the PLC memory addresses set in the screen data file.
Communication Error Received Code No. 36	The number of monitor registration points is too small.	Correct the number of monitor registration points. For monitor registration, refer to the user manual of the PLC you are using.

PROFIBUS-DP

Error Messages	Contents	Solution
Time-Out	"Check" is displayed 2 or 3 seconds before this error occurs when connecting the V8 series and PROFIBUS-DP in the RUN mode.	The setting for [Own Stat. No.] on the V8 series is discrepant with that for [Address] for [V8 series] on the SIMATIC Manager. Check and correct the setting.
	A screen is displayed instantaneously (= communications performed) before this error occurs when connecting the V8 series and PROFIBUS-DP in the RUN mode.	The DB address set on the V8 screen may not exist on the PLC (memory over). Check the setting.

SX Bus

Error Messages	Contents	Solution
Error SX Bus I/F Board	The SX Bus cable is not connected, or the SX Bus unit I/F has an error.	Check the SX Bus cable connection. If the problem persists, contact your local distributor.
Communication Error Received Code No. 22	The communication data has an error.	Data may be disrupted because of noise. Fix noise.
Access denied by Loader	The PLC loader is being accessed so that processing is not performed on the V8 series. (This error occurs during program transfer from the PLC loader for most cases.)	Wait for the completion of processing at the PLC loader, and try again.
Communication Error Received Code No. 28		
Communication Error Received Code No. 44	An attempt to access memory that does not exist within the PLC is made.	Check the PLC memory addresses set in the screen data file.
Communication Error Received Code No. 45		
Communication Error Received Code No. A0	The specified PLC CPU No. does not exist.	Check the PLC memory addresses (CPU No.) set in the screen data file.

DeviceNet

○: Extinguished ●: Illuminated ◎: Blinking

Error Messages	LED		Contents	Solution
	MS	NS		
Initialization error	● Red	○	Reading or writing to RAM is not performed normally during initialization check.	<ul style="list-style-type: none"> Turn the power on again. If recovery is not possible, a fault is suspected.
			Start-up information check error: The baud rate is outside the specified range.	<ul style="list-style-type: none"> Make the baud rate (using DIP switch 7 and 8) the same as set for the master on "CU-07" and turn on the power again. If recovery is not possible, a fault is suspected.
			Start-up information check error: Excessive size for input	<ul style="list-style-type: none"> On the V-SFT-5 editor, select [System Setting] → [Device Connection Setting]. In the [Input/Output Word Counts Setting] tab window, enter the desired value of up to 128 words for [Input Range]. Then turn on the power again.
			Start-up information check error: Excessive size for output	<ul style="list-style-type: none"> On the V-SFT-5 editor, select [System Setting] → [Device Connection Setting]. In the [Input/Output Word Counts Setting] tab window, enter the desired value of up to 128 words for [Output Range]. Then turn on the power again.
BUS OFF Error	● Green	● Red	<ul style="list-style-type: none"> The communication cable is short-circuited at start-up. The baud rate does not match the setting for the master. 	<ul style="list-style-type: none"> Check the wiring and turn on the power again. Make the baud rate (using DIP switch 7 and 8) the same as set for the master on "CU-07" and turn on the power again.
Node Address Duplication Error	● Green	● Red	The same node address is already used for the master or some other slave.	<ul style="list-style-type: none"> Check the node address and correct it to an address which is not used yet (using DIP switch 1 to 6) on "CU-07". Then turn on the power again.
Network Error	● Green	○	The network power is off.	<ul style="list-style-type: none"> Turn on the network power supply.
			No other devices exist on the network.	<ul style="list-style-type: none"> Check the wiring and turn on the power again. Make the baud rate (using DIP switch 7 and 8) the same as set for the master on "CU-07" and turn on the power again.
		◎ Red	I/O time-out: Communication with the master has become disabled.	<ul style="list-style-type: none"> Check the conditions of the master power supply. Check the wiring.
		◎ Green	No connection exists.	<ul style="list-style-type: none"> Check the wiring.

Error Messages	LED		Contents	Solution
	MS	NS		
Definition Error	–	–	The returned error code is not supported by the DeviceNet.	Review the settings below: <ul style="list-style-type: none">• Master setting• CU-07 setting• V-SFT-5 setting• Wiring

* Depending on the errors detected, turning on the power again may be necessary on the master as well as on the V8 series.

2. Data Loading

If an error is detected on the screen data in the RUN mode, the following messages are displayed on the V8 series.



Error Messages	Contents	Solution
Screen No. Error	There is no setting for the received screen.	At the start of communications, the V8 series regards the value in the read area "n + 2" as the screen number. Check that this value is an existing screen number on the controller.
Error : XX (XX : XXX)	There is an error in the created screen data.	<p>According to the item number and the sub-item number displayed on the V8 series, find the edited screen where the error occurs. Check the contents of the error (error number) and remove the error.</p> <p>Error : XX (XX : XXX)</p> <p>Sub-item No. Item No. Error No.</p> <p>For details on the item number and sub-item number, refer to the V8 Series Reference Manual.</p>

3. Warning

A message may be displayed on the Main Menu screen. This is a warning message. For the warning details and solutions, refer to the V8 Series Reference Manual and correct screen data.

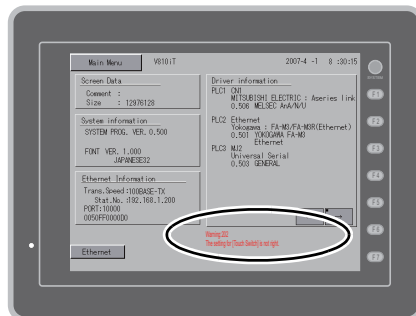

4. SYSTEM ERROR

When a system error is detected, the following error screen is displayed on the V8 series.

System Error screen

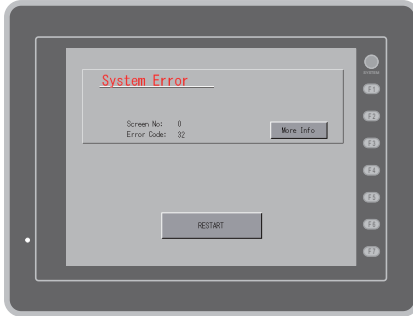

Error Code: XX

- 1: Watchdog timer error
- 11: Switch table error
- 30: Request for displaying full error
- 31: Memory allocation system error
- 32: General exceptions/MMU address system error
- 33: RTOS system error
- 34: Memory error
- 35: Inaccurate memory error

The source of the error could be one of the following three problems.

- 1) Program crash due to noise
- 2) Hardware problem
- 3) Bad program

If any of these errors occurs, contact your local distributor.

5. Touch Switch Is Active

If the power is turned off while a touch switch is activated, the error screen shown on the right is displayed. Remove your finger from the screen. If the error screen remains displayed, contact your local distributor.





2. Troubleshooting

In the Event of an Error

Perform the steps below:

1. If the current error matches a symptom in the following table, correct it by following the instructions provided.
2. If the error does not match the symptoms in the table, contact your local distributor.
Please provide the distributor with the information on the MONITOUCH model, serial number, symptom of the error, error message, etc.

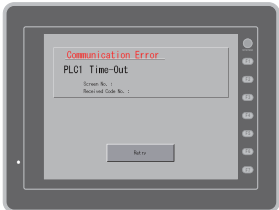
Probable Symptoms

Symptom	Cause	Solution
<p>MONITOUCH is connected to controllers; however, communication fails. "Communication Error: Time-Out" appears on the screen.</p> 	<p>Probable causes are:</p> <ol style="list-style-type: none"> 1) Cables are not connected correctly or any cable is disconnected. 2) Parameter settings in the controller are not correct or disagree with the V8-series settings. 3) The MONITOUCH is faulty. 	<p>Solutions are:</p> <ol style="list-style-type: none"> 1) Check the cable connection. 2) Recheck the parameter settings in the controller. 3) Perform a self-loop test on the I/O Test screen (page 5-35). If the test is not successful, please return MONITOUCH to your local distributor immediately.
<p>Communications have been successful. However, opening a certain page always causes a "Communication Error: Error code received" error.</p> 	<p>The error code denotes a controller error (NAK).</p> <ol style="list-style-type: none"> 1) When the error code appears only on a certain screen, a memory address that does not exist on the controller may be set on the V8-series screen. 2) When the error code appears at power-on, the memory address set for buffering area or initial macro or in the [Read/Write Area] tab window ([System Setting] → [Device Connection Setting]) may not exist in the controller. 	<ol style="list-style-type: none"> 1) Check if any address outside the allowable range for controller memory is set on the screen. 2) Check if the address set for buffering area or initial macro or in the [Read/Write Area] tab window ([System Setting] → [Device Connection Setting]) is outside the allowable range for the controller memory.

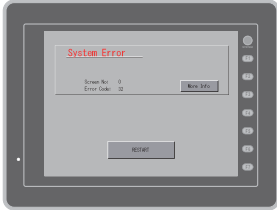
Symptom	Cause	Solution
<p>Communications have been successful. However, "Communication Error: Parity" or "Communication Error: Framing" suddenly occurs.</p> 	<p>Noise may cause the error.</p>	<p>Check if appropriate measures are taken against noise.</p> <p>Example: Check if communication and power cables are bundled together. Try to attach a ferrite core to the communication cable. Try to attach a noise filter to the power supply, etc.</p>
<p>"SYSTEM ERROR: xx" occurs.</p> 	<p>The following causes are probable, depending on the symptoms.</p> <ol style="list-style-type: none"> 1) Turning the power off and back on corrects the error. ↓ Communication failed because of improper timing. 2) Turning the power off and back on does not correct the error. ↓ A certain condition always causes the error. Or MONITOUCH is faulty. 3) A CF card is inserted. ↓ The CF card (front and back) may be reversed. <p>If none of the above matches your error, contact your local distributor.</p>	<ol style="list-style-type: none"> 1) If communication is stable after turning the power on again, continue and observe operation. 2) Make a note of the information on error number, etc. displayed on the screen and contact your local distributor. 3) Check that the inserted CF card faces the correct side.
<p>Switches do not work.</p>	<ol style="list-style-type: none"> 1) Switches do not work in the RUN mode. A beep sounds. ↓ Is the switch interlock enabled? 2) Switch activation position is wrong. On the I/O Test screen displayed from the Main Menu screen, press the [Switch Check] switch. On the touch switch test screen, a position different from the pressed position is activated. ↓ The switch activation position may be misaligned. 3) Switches do not work even in the STOP mode. On the I/O Test screen displayed from the Main Menu screen, press the [Switch Check] switch. When the touch switch test screen is pressed, nowhere is activated. ↓ MONITOUCH switches may be faulty. 	<ol style="list-style-type: none"> 1) Check the settings of switch functions, etc. on the V-SFT-5 editor. 2) Perform a touch switch adjustment (page 5-43). 3) Return MONITOUCH to your local distributor.

Symptom	Cause	Solution
The screen becomes dark or black.	1) Touching the screen restores it to the previous illuminated state. ↓ The backlight operates automatically as preset. 2) Touching the screen does not restore it. However, the POWER lamp is lit. ↓ The backlight may be at the end of its life. Or MONITOUCH may be faulty.	1) The time for turning off the backlight can be changed on the V-SFT-5 editor. 2) Return MONITOUCH to your local distributor.
Screen data cannot be transferred.	1) Screen data transfer has never succeeded. ↓ There may be some errors in the settings on the computer. 2) Screen data transfer was possible, but is disabled now. ↓ The MONITOUCH may be faulty. Or, there may be some errors in settings. 3) Only serial transfer is successful. ↓ There may be some errors in the Ethernet or USB settings.	1) In the [Transfer] dialog on the V-SFT-5 editor, decrease the baud rate by one level. Also check that the correct COM port is selected. 2) Check if the modem connection mode is selected. ("Modem Connect Mode" displayed at the bottom of the Main Menu screen denotes the mode.) Also perform an RS-232C self-loop test (page 5-35). 3) Transfer via Ethernet Check that the IP addresses set on the V-SFT-5 editor and MONITOUCH are the same. Also check if any error due to Ethernet connection occurs on MONITOUCH. Transfer via USB Is the USB driver recognized? Has the driver been installed successfully (page 2-25)? If the problem persists, contact your local distributor.

7 Inspection and Maintenance

1. Inspection and Maintenance
2. Warranty Policy

1. Inspection and Maintenance

**DANGER**

Be sure to turn off the power before conducting inspection or maintenance. Failure to do so could cause an electric shock or damage to the unit.

Daily Inspection

- Check that the screws on the V8 series are tightened firmly.
- Check that the connectors and terminal screws used for connection with other devices are tightened firmly.
- If the display surface or frame is dirty, wipe it with a soft cloth soaked in alcohol (commercially available).
- Conduct periodical inspection once or twice a year. The number of inspections may be increased as necessary if facilities are relocated or modified, or the environment is hot, humid, or dusty.

Periodical Inspection

Inspect the following points periodically.

- Are the ambient temperature and humidity appropriate?
0 to +50°C, 85%RH or less
- Are the environmental conditions appropriate?
No excessive dust, and no conductive dust
- Does the atmosphere contain no corrosive gas?
- Is the source voltage in the allowable range?
With AC power supply: 100 to 240 VAC \pm 10%
With DC power supply: 24 VDC \pm 10%
- Are the V8-series mounting screws tightened firmly?
- Are the connectors and terminal screws used for connection with other devices tightened firmly?
- Is the lithium primary battery within the expiry date?
About 5 years from the date of your purchase

2. Warranty Policy

Inquiries about Failure

Please direct inquiries about failure or repair to your local distributor. Your information on the MONITOUCH model, serial number, symptom of the failure, error message (if shown), etc. will be appreciated.

- * An inquiry form is provided on the final page (page 7-3) of this chapter. The form may be used for your inquiry.

Warranty Period

The product is under warranty for one year after the date of purchase or delivery to the specified place. On the assumption that the maximum stock period of the product after manufacture is 6 months, the warranty period is limited to 18 months (checked by the serial number) after manufacture. When a warranty period is specified in the contract, however, the period in the contract takes precedence.

Free-of-charge Repair

If the product fails before the expiry of the warranty, it will be repaired free of charge. However, repair of any failure resulting from the causes below will be chargeable even within the warranty period.

- Breakage of or damage to the appearance (case or surface sheet), touch switches, LCD, or other components due to dropping, impact, or mishandling
- LCD or backlight at the end of life
- Fusion of a printed circuit board pattern associated with connection to external devices, or fusion of a pattern in the terminal block or connector section of a printed circuit board caused by short-circuiting of external load circuit
- Overvoltage or different voltage applied due to wiring mistake (power supply terminal, external communication terminal, or other terminal blocks)
- Failure caused by lightning surge
- Failure due to the entry of conductive substances, water, solvent, particles, etc. under inappropriate environmental conditions
- Failure due to inappropriate environmental conditions (e.g. corrosive gas or high humidity)
- Failure due to vibration or impact exceeding the specified level
- Disassembly and modification by the customer or failure obviously resulting from improper handling by the customer

Chargeable Repair

Any failure that occurs after the expiry of the warranty or does not satisfy the requirements for the free-of-charge repair will be repaired on a chargeable basis.

Inquiry Form

Your name			
Company name			
Contact	Phone		Fax
	E-mail		
Model code(*1)		Ser. No. (*1)	
MONITOUCH version (*2)	SYS. PROG. Ver. :	I/F DRV. Ver. :	
Purchased from: (Distributor)			
Person in charge		Date of purchase	
Symptom			
(Please describe the symptom of the failure and also include the error message if any is displayed.)			

- *1 See the label on the back of MONITOUCH for the model code and serial number (seven digits plus one letter of the alphabet).

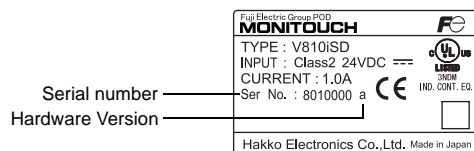

- *2 Enter the version if it can be checked.
The version is displayed on the Main Menu screen (page 5-3).

MEMO

Please use this page freely.